

# Operating Instructions

## L2D2-HK

L2D2 Doctor's device in a cabinet

**DKL**  
YOUR DENTAL UNIT

Manufacturer:  
DKL CHAIRS GmbH  
An der Ziegelei 3  
D-37124 Rosdorf  
Germany  
+49 (0)551-50060  
info@dkl.de  
www.dkl.de



Form no. GEN-L2D2HK  
Rev. 06 / 01.04.2024  
Subject to change without notice







## Contents

Symbols in the Operating Instructions	3
Symbols inside the Unit	4
Introduction	5
Electromagnetic Compatibility (EMC)	6
Safety Notes – General	7
Safety Notes – Doctor’s Device	8
Safety Notes – Transmission Instruments	8
Technical Specifications	9
Media Requirements	10
Installation Requirements	11
Dimensions in Millimetres	12
Product Description	13
Foot Controller	15
Icons – Display	16
Icons – Navigation Touch Display	17
Icons – Setup	18
Putting the Treatment Unit into Operation	19
Creating a User	20
Managing Users	21
Main Menu Instruments	21
General Instrument Functions	22
Starting the Turbine	24
Starting the Turbine (Advanced Air)	24
Starting the Electric Motor	25
Starting the Piezo Scaler	27
Function Syringe Luzzani Minilight	28
Cleaning and Disinfection of the Surfaces	29
Cleaning and Disinfection of the Instrument Holders	30
Check for Oil Residues in the Turbine Return Air	30
Bottle Care System	31
Flushing Function with the Bottle Care System	32
Intensive Flushing with the Bottle Care System	33
Setting Media Instruments	34
Maintenance and Inspection	35
Safety Inspections	35
Error Messages	36
Warranty Declaration + Waste Disposal	38
EMC - Manufacturer’s Declaration	39













## Annex

- > Instructions for Use W&H Dentalwerk Bürmoos GmbH Electric motor EM-12L
- > Instructions for Use W&H Dentalwerk Bürmoos GmbH Piezo Scaler PB 5
- > Instructions for Use W&H Dentalwerk Bürmoos GmbH FOOT CONTROL S-NW
- > Use Manual Syringe Luzzani Minilight

## Symbols in the Operating Instructions

	WARNING! (risk of injury)		CAUTION! (to prevent damage occurring)		General explanations, without risk to persons or objects
	Thermodisinfectable		Sterilisable up to the specified temperature		Call customer service!

## Symbols on the unit

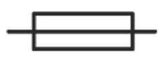
	Consult instructions for use or consult electronic instructions for use		ON / OFF		Do not dispose of with household waste
	CE-marking with identification number of the notified body		Foot controller		Type B application part
	Manufacturing date		Model (designation)		Serial number
	Manufacturer		Medical device		UDI - Product Identification
<b>V</b>	Electrical voltage	<b>AC</b>	Alternating current	<b>VA</b>	Electrical power consumption
<b>A</b>	Current intensity	<b>Hz</b>	Frequency of alternating current		
	Electrical fuse				

## Symbols inside the Unit



Earth conductor connection -  
Protective earth



Functional  
earth

N

Connection point for  
neutral conductor

## Symbols on the packaging



Air humidity, limitation

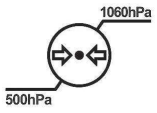

Atmospheric pressure limitation

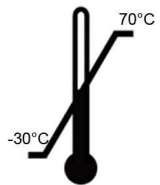

Permissible temperature range



Transport upright; top



Protect from moisture!

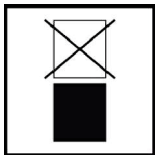

Do not stack!



Fragile

## Introduction



### **For your safety and the safety of your patients**

These operating instructions are intended to explain how to use your product. However, we must also warn of possible dangerous situations. Your safety, the safety of your team and, of course, the safety of your patients are very important to us.

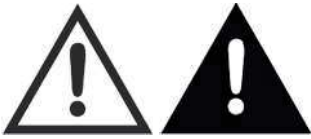

Please observe the safety instructions!

### **Intended purpose**

This treatment unit is used for the diagnosis and therapy of children and adults in the field of dentistry.

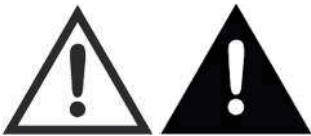

Improper use can damage the treatment unit and thus pose risks and hazards to the patient, user and third parties.

### **Qualification of the user**

The DKL treatment unit may only be used after medically, professionally and practically trained personnel have been instructed. The development and design of the treatment unit were geared towards the target group of dentists, dental hygienists, qualified dental employees (prophylaxis) and dental assistants.



Production according to EU directive  
The medical device complies with the provisions of regulation (EU) 2017/745.



### **Responsibility of the manufacturer**

The manufacturer can only be held responsible for the impact on the safety, reliability and performance of the treatment unit if the following instructions are observed:

- > The dental unit must be used in accordance with these operating instructions.
- > If assembly, additions, new settings, changes or repair work is carried out by DKL or trained technicians authorised by DKL or personnel of authorized dealers trained by DKL.
- > The electrical installation of the room must comply with the regulations of the IEC 60364-7-710 standard („Erection of electrical installations in rooms used for medical purposes“) or comply with the regulations applicable in your country.
- > The recommended annual maintenance is carried out and any repair work in this context meets the requirements of EN 62353.
- > „Repeat tests and pre-commissioning tests of medical electrical equipment and systems – general regulations“are fully complied with.
- > The national legal regulations are observed when using the device, in particular the applicable health and safety regulations and accident prevention measures.

## Electromagnetic Compatibility (EMC)



Medical electrical equipment is subject to special precautions with regard to EMC and must be installed and commissioned in accordance with the EMC instructions. DKL guarantees that the dental unit complies with the EMC guidelines only if original DKL accessories and spare parts are used. The use of accessories and spare parts not approved by DKL may lead to an increased emission of electromagnetic interference or to a reduced resistance to electromagnetic interference.



The EMC manufacturer declaration can be found on page 39.



HF communication equipment

Do not use portable and mobile HF-communication equipment (such as mobile telephones) during operation. These can affect medical electrical devices.



Risks due to electromagnetic fields

The functionality of implantable systems, such as cardiac pacemakers and implantable cardioverter defibrillators (ICD), can be influenced by electric, magnetic and electromagnetic fields.

- > Before using the product, ask the patient and user about implanted systems and check the use.
- > Perform a risk-benefit analysis.
- > Do not place the product near implanted systems.
- > Do not place the instruments on the patient's body.
- > Take appropriate emergency precautions and respond immediately to health changes.
- > Symptoms such as increased heart rate, irregular pulse, and dizziness may be signs of problems with a pacemaker or ICD.

## Safety Notes – General



- > Before being put into initial operation, the treatment unit must be kept at room temperature for 24 hours.
  - > Before each application, check the treatment unit and the instruments with cables for damage and loose parts.
- 
- > Do not operate the treatment unit if it is damaged.
  - > Check the set parameters each time you restart the unit.
  - > Carry out a test run before each application.
  - > The application and timely shutdown of the system is the user's responsibility.
  - > Make sure that in the event of a device or instrument failure, the treatment can be completed safely.
  - > Use only original DKL fuses.
  - > Never touch the patient and the electrical connection at the treatment unit at the same time.
  - > Do not lean on the doctor's device, the assistant's device, the tray or the operating lamp.
  - > When moving the treatment chair, the doctor's device, the assistant's device, the tray or the operating lamp, pay attention to the patient and the practice personnel.
  - > Always switch off the treatment unit before leaving the practice.



Hygiene and care before using the device

- > Clean and disinfect the device immediately before or after each treatment!
- > Wear protective clothing.



Observe your country-specific guidelines, standards and specifications for cleaning, disinfection and sterilisation.



The treatment unit is classified as an „ordinary device“ (closed device without protection against water ingress).



The treatment unit is not suitable for use in an explosive atmosphere or in explosive mixtures of anaesthetics with oxygen or nitrous oxide.



The treatment unit is not suitable for use in rooms with an oxygen enriched atmosphere.

## Safety Notes – Doctor's Device



- > Before putting the device into initial operation and after downtimes (weekends, (public) holidays etc.), flush the water lines intensively.
- > Flush all instrument connections for 2 minutes before starting work.
- > Rinse used instruments for 20 seconds after each treatment.



Risk of injury or infection caused by instruments that are not in use:  
The arrangement of the instruments may cause injury or infection to the hand and forearm when accessing the tray or the display.  
Therefore, when accessing the tray or the display, pay attention to the arrangement of the instruments.



Highly immunosuppressed patients or patients with specific lung diseases should not get into contact with the water of the treatment unit.  
It is recommended to use sterile solutions.



Never touch the USB plug below the doctor's device and the patient at the same time.



- > Do not exceed the maximum permissible load of 2 kg on the doctor's device.

## Safety Notes – Transmission Instruments



Follow the instructions and safety notes in the operating instructions for the transmission instruments.

- > For the motors, only use transmission instruments with transmission systems that are ISO 3964 (DIN 13940) compatible and approved by the manufacturer.
- > For air-powered instruments, only use coupling systems according to ISO 9168.
- > For air-powered instruments, only use coupling systems with anti-retraction stop for contaminated cooling water.
- > Observe the information provided by the manufacturer of transmission instruments regarding transmission ratio, maximum speed and maximum torque.
- > Only use faultless instruments and with the motors pay attention to the direction of rotation of the rotating instrument. Follow the manufacturer's instructions.
- > Plug in the transmission instrument only when the device is at a standstill.
- > If the coolant supply fails, switch off the transmission instrument immediately.
- > Before each use, check the transmission instrument for damage and loose parts.
- > Never operate the clamping mechanism of the transmission instrument while using the device or while the device is running down.
- > Never reach into the instrument while it is running or running down.
- > Avoid overheating of the treatment site.
- > Check the secure placement of the instrument.



## Technical Specifications

Supply voltage	230V AC
Nominal voltage	max. 1 A
Frequency	50/60 Hz
Fuse	T 3,15A H 250V primary / time-delay
Maximum power consumption	250 VA
Device class according to MDR (EU) 2017/745	Ila
Protection class	Device of protection class I
Application parts	Type B application parts
Contamination level	2
Over voltage category	II
Power cable	3x1,5 mm <sup>2</sup>
Potential equalisation	1x 4 mm <sup>2</sup>
Free end electrical cables above floor	500 mm
Fuse for domestic installation	Circuit breaker: 16 A medium-lag Recommendation: circuit breaker type C
Degree of protection against ingress of water	Ordinary device (without protection against water ingress). The foot control is waterproof according to protection class IPX8.



Permanently connected device. In order to avoid the risk of electric shock, this device may only be connected to a power supply with an earth conductor.

Weight	
L2D2-HK	max. 40 kg

Transport and storage conditions	
Ambient temperature	-30 to +70 °C
Relative humidity	10 to 80 %
Atmospheric pressure	500 hPa to 1060 hPa

Operating conditions	
Ambient temperature	10 to 35 °C
Relative humidity	15 to 80 %
Atmospheric pressure	700 hPa to 1060 hPa
Installation site	≤ 3,000 m above sea level The treatment unit is not suitable for operation in hazardous areas.

## Media Requirements



Connection to the public drinking water supply

The treatment unit is equipped with a bottle care system (not connected to the public drinking water supply).

Media air	
Air inlet pressure	max. 7 bars
Air consumption	80 NI/min
On-site air filtration	$\leq 100$ particles size 1 - 5 $\mu\text{m}$ referred to one $\text{m}^3$ of air
Oil content	$\leq 0.5\text{mg}/\text{m}^3$ , oil-free compressors; the compressor must suck in hygienically perfect air.
Humidity	Pressure dew point $\leq -20$ °C at atmospheric pressure
Compressed air supply	Pipe 10x1 mm, angle valve outlet 3/8"
Air connection above the floor	min. 40 mm, max. 60 mm



Clean air pipes before installing the unit.

Chips and other foreign substances could be flushed or blown into the treatment unit.

Metal chips can interfere with the function of pneumatic components. Filters are clogged by foreign substances.

- When assembling, make sure that there are no chips or other foreign substances in the pipes.
- Blow out the air ducts.
- Make sure that no further foreign substances get into the pipes and ducts after rinsing or blowing out.

Filter in the treatment unit		maintenance interval	Article number
Particle filter compressed air inlet	50 $\mu\text{m}$	Replace annually	200095-E1

## Installation Requirements L2D2-HK

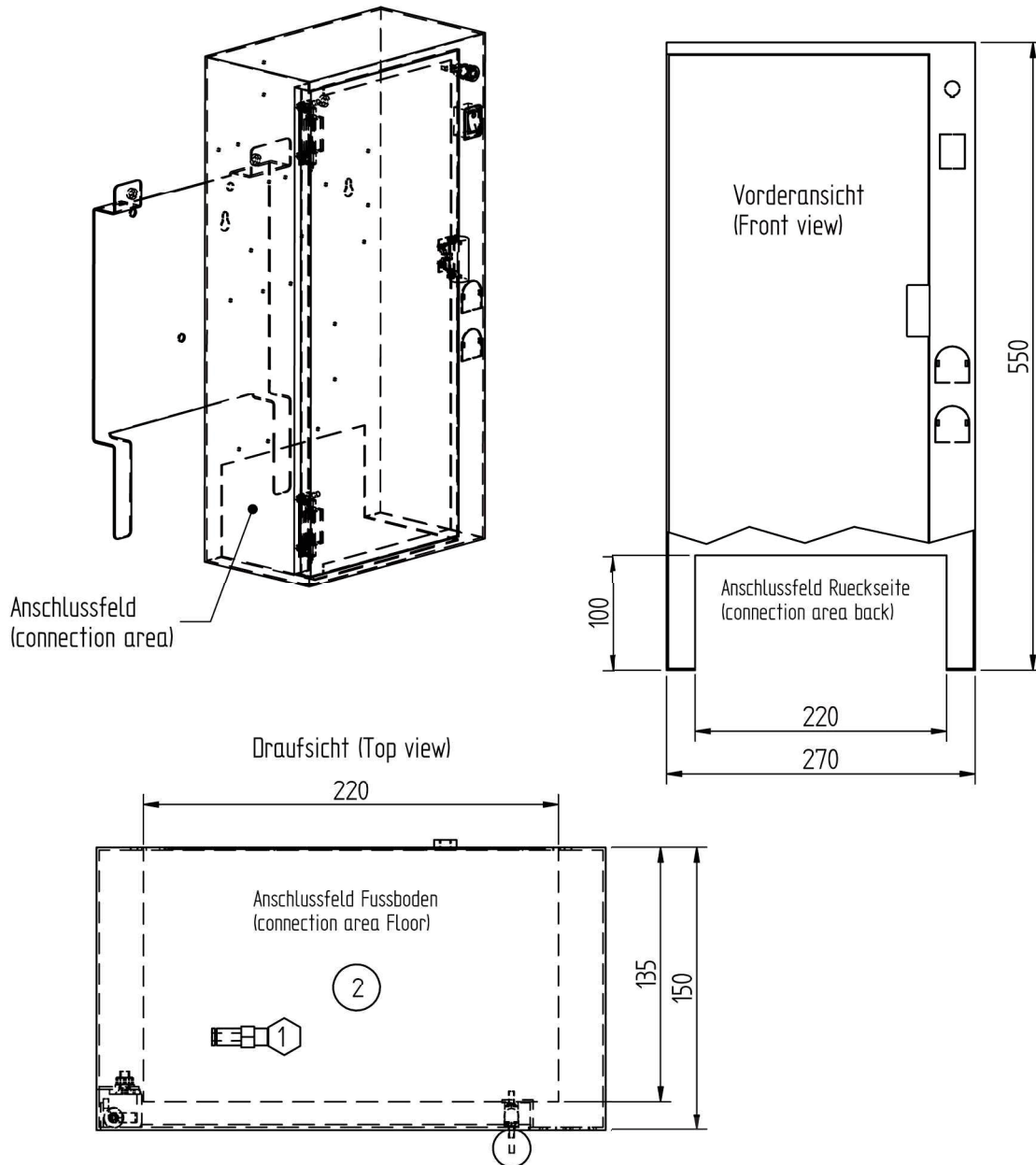

### Requirements for Supply Connections

①	Air: pipe min. 10x1 mm, angle valve outlet 3/8"
②	Power cable 3x1.5 mm <sup>2</sup>
②	Equipotential bonding 1x 4 mm <sup>2</sup>

Dimensions in Millimetres

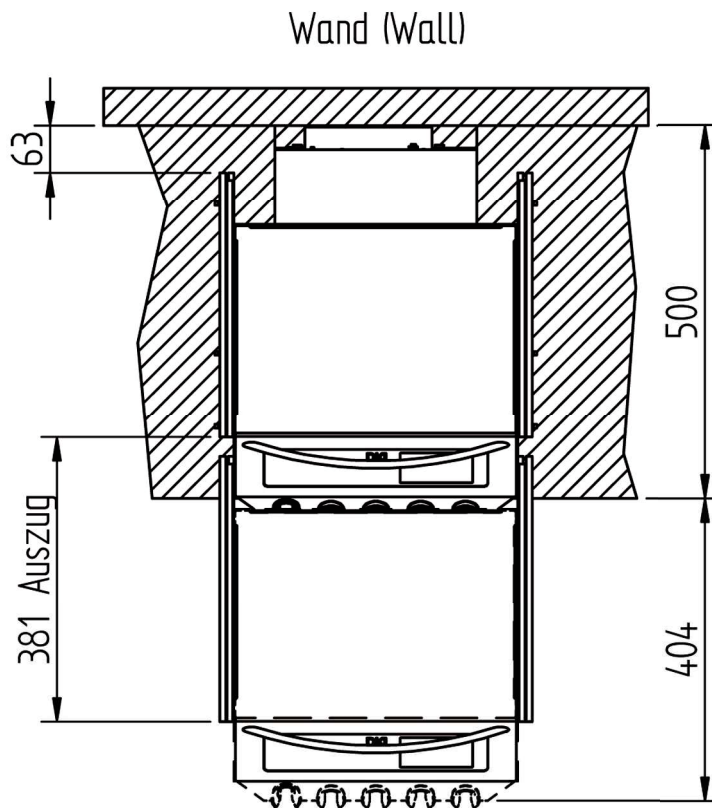
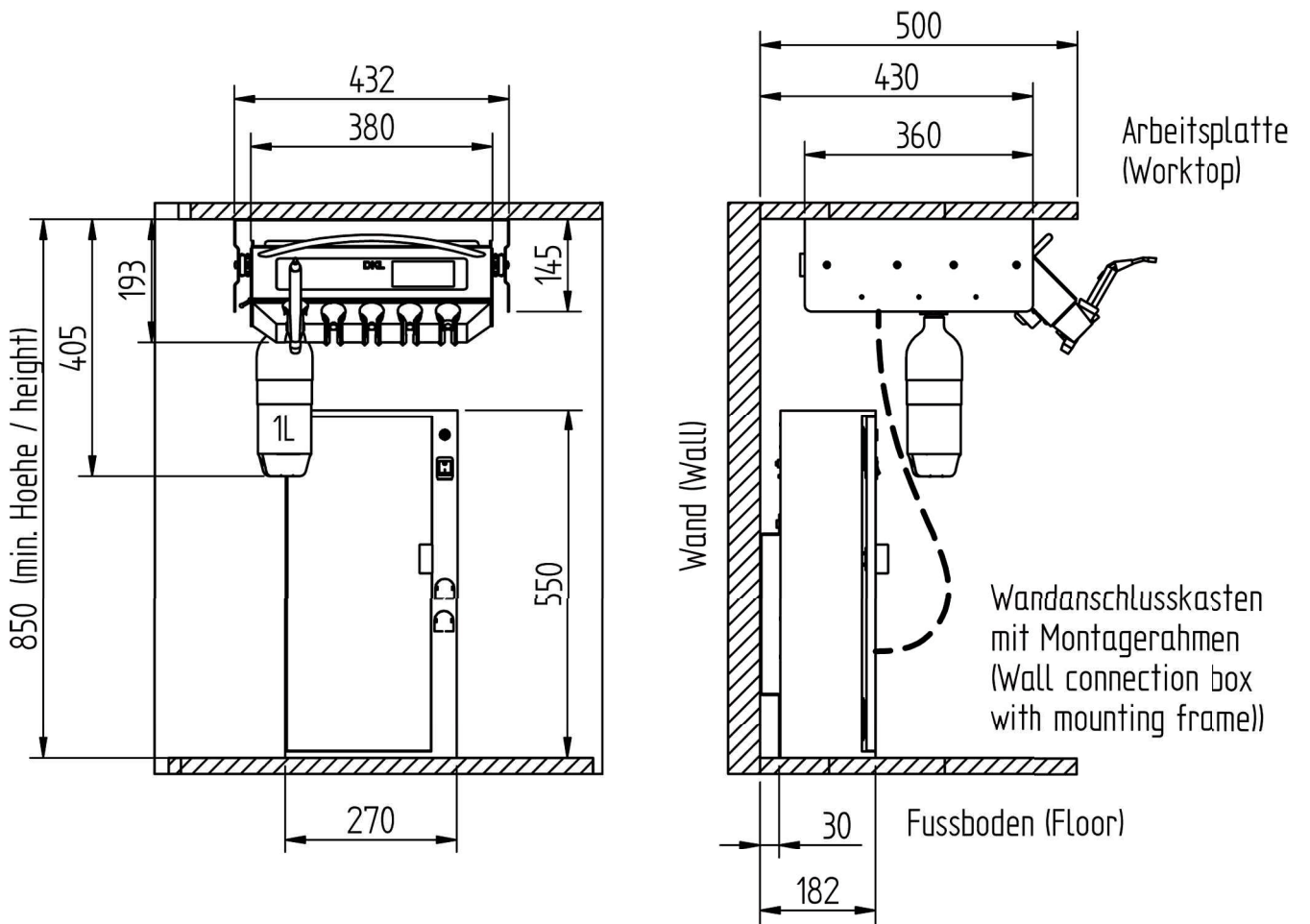

## Product Description

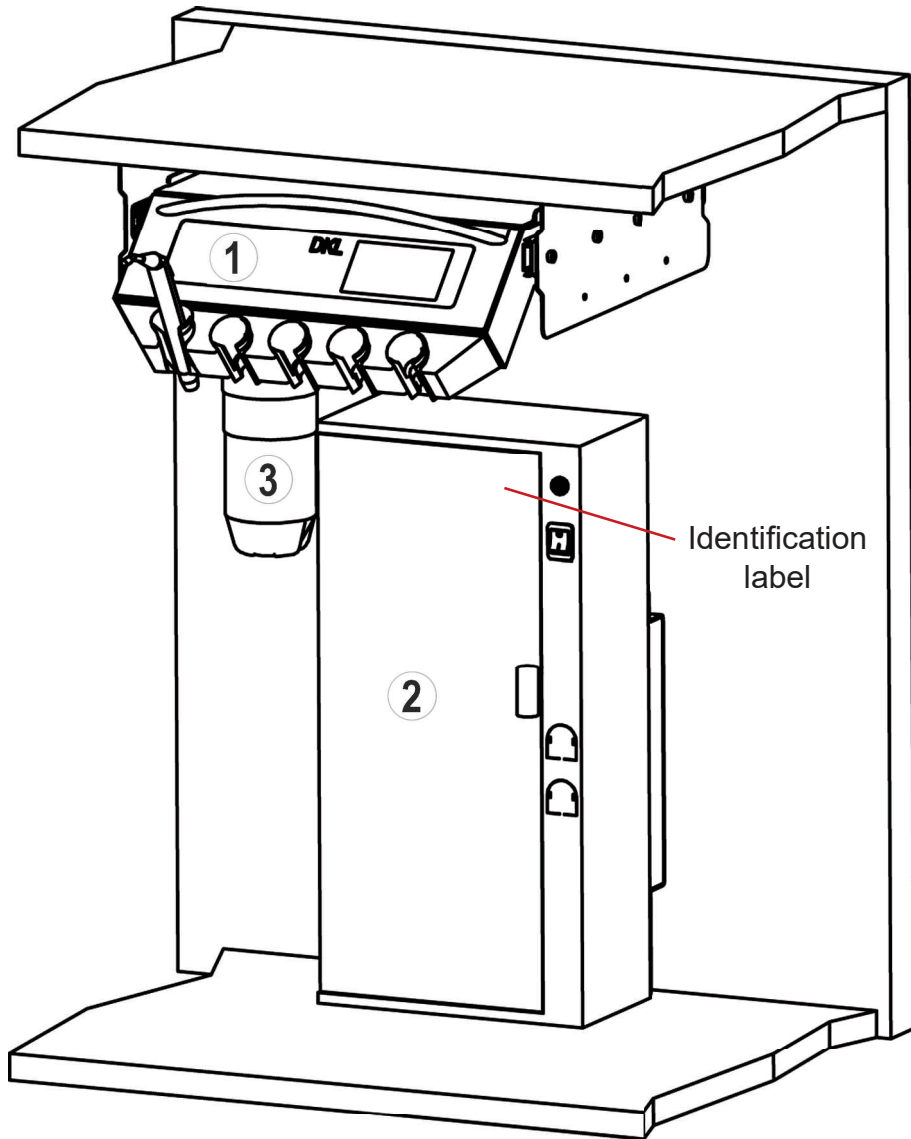

①	Doctor's device in a cabinet
②	Wall connection box
③	Bottle Care System / Water supply
④	Foot controller doctor's device (wireless)



## Product Description

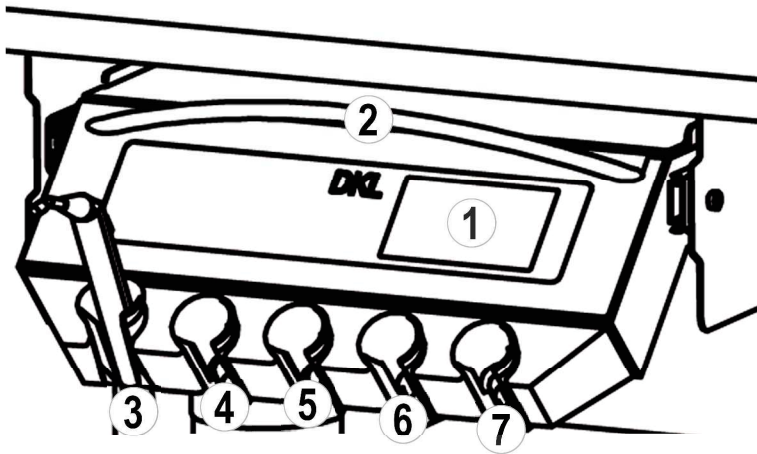

①	Display
②	Handle
③	3-function syringe
④	Turbine connection
⑤	Micromotor
⑥	Micromotor
⑦	Piezo scaler



### Connecting the instrument hoses:

The instrument hoses can be connected or disconnected via a plug connection under the doctor's device. Depending on the equipment of the model, the doctor's device is equipped with the following instruments (from the left): turbine connections, micromotor(s), piezo scaler and the syringe. The instrument holders are marked on the back. Do not connect the tubes crosswise.



Marking	Type of holder
T	Turbine connection
M	Micromotor
S	Syringe
P	Piezo Scaler

## Foot Controller

The wireless S-NW foot controller enables hands-free operation of the instruments.



Only use high-quality disposable AA / Mignon / LR6 / 1.5 V batteries.

You will find further information on use, safety instructions, cleaning and battery replacement in the W&H instruction manual foot controller S-NW, S-N2.



You can find an application film at [www.youtube.com/watch?v=R803BCMsbyk](http://www.youtube.com/watch?v=R803BCMsbyk) DKL Germany.  
Video: DKL CHAIRS L2-D2 SERIES WITH TOUCH SCREEN FUNCTIONS FOOT CONTROLLER



LINK: <https://youtu.be/R803BCMsbyk>

①	Start signal for instruments
②	Press briefly: coolant
②	Press long: chipblower
③	Programmes to activate instruments
④	Press briefly: left/ right-hand rotation micro-motor
⑤	Clamp for positioning

## Icons – Display



Treatment chair, activate programme run  
(These functions are not available for the cabinet system and the SOLO system.)

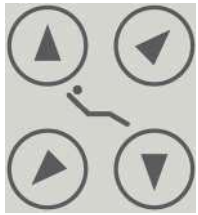

Lifting the treatment chair and moving the back rest  
(These functions are not available for the cabinet system and the SOLO system.)



Display lock



Bell  
(These functions are not available for the cabinet system and the SOLO system.)



Cup filler  
(These functions are not available for the cabinet system and the SOLO system.)



Bowl rinser  
(These functions are not available for the cabinet system and the SOLO system.)



You can find application films at [www.youtube.com](http://www.youtube.com) DKL Germany.  
Playlist: DKL CHAIRS L2-D2 SERIES DOCTOR'S DEVICE WITH TOUCH SCREEN

LINK: [https://www.youtube.com/playlist?list=PLBx4baZAs6WgjO9xNPs3m30bNHsd\\_DR4e](https://www.youtube.com/playlist?list=PLBx4baZAs6WgjO9xNPs3m30bNHsd_DR4e)



## Icons – Navigation Touchscreen



Add user



Back



Confirm / save



Setup



To the next page



Edit



Decrease / Increase



Flush menu

## Icons – Information touch screen



Setting selected



Foot controller, wireless



Information



Error message, no further work is possible



Favourite selected



red = replace battery



Information with selection option



Error message, further work is possible

## Icons – Setup



Touchscreen lock



Manage users



System



Setup foot controller



Setup touchscreen lock



Sound ON



Sound OFF (except warning sounds)



Device information



Language



Setup service

## Putting the Treatment Unit into Operation



Only use your finger to operate the touchscreen. Operating the touchscreen with hard objects can scratch or damage the surface.



Putting the unit into operation

Before putting your treatment unit into initial operation, an intensive flushing must be carried out (→ page 33).

Activating / Deactivating the Treatment Unit

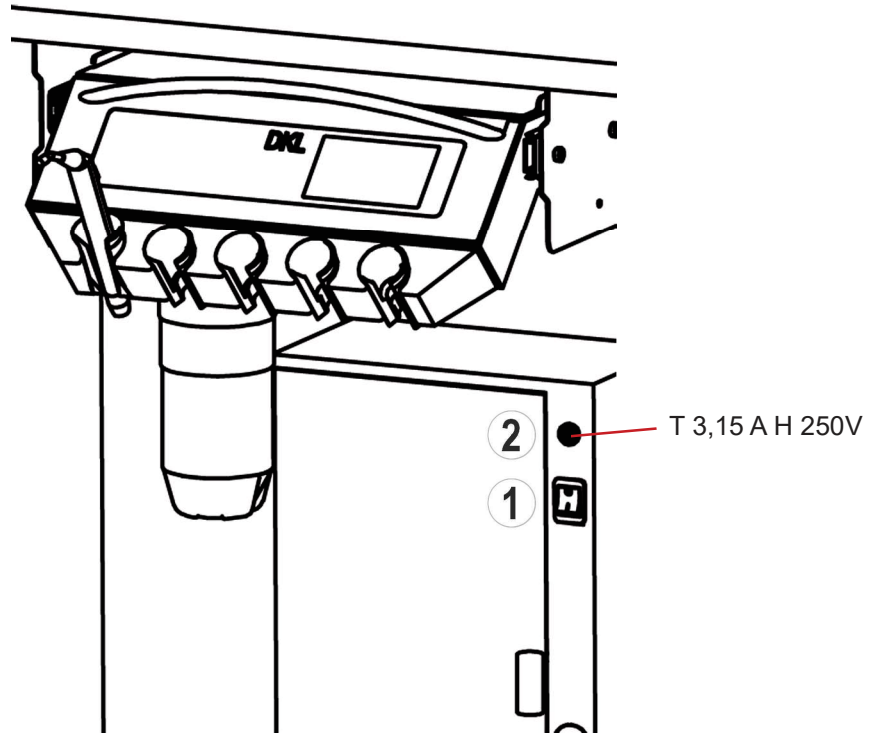

The treatment unit is equipped with a power switch ① on the chair base. The power switch connects the treatment unit with the power supply. In the event of longer downtimes, the treatment unit should be disconnected from the power supply. The treatment unit contains a device fuse ②. Switch on the treatment unit at the power switch. The power switch lights up green.

After the unit has been switched on, the operating system is booted.



## Creating a User



Activate the setup



Add a user



Enter the user on the on-screen keyboard (max. 15 characters)



Store the user



The new user is displayed in the “Manage Users” menu

## Activating a User



Select a user



Confirm the user



The active user is displayed under “My Favourites”.



Six user profiles can be created.

## Changing the User



Activate “My Favourites”



Select a user



Confirm the user



The active user is displayed under “My Favourites”



You can find an application film at [www.youtube.com/DKL\\_Germany](http://www.youtube.com/DKL_Germany).  
Video: DKL DENTAL D2-L2 SERIES FUNCTION USER ADMINISTRATION

LINK: <https://youtu.be/xiJQcrJfxSU>

## Managing Users



Activate setup



Manage users



Activate user



Copy user



Delete user



Rename user



Activate user

## Main Menu Instruments

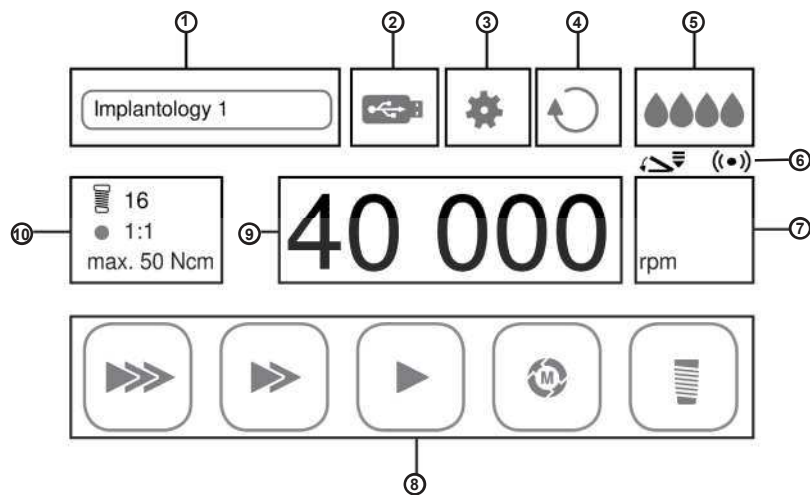

1	My favourites	6	Wireless foot controller (VARIABLE or ON/OFF)
2	Documentation (DOCU), if Implantmed	7	Display work mode
3	Setup	8	Display programme mode
4	Right/left-hand rotation	9	Speed (rpm) / torque (Ncm) / power (1-40)
5	Coolant: water (spray) or sterile solution (pump)	10	ProConfigure the programme

## General Instrument Functions

### Adjusting the Coolant



Spray on (water)



Spray off



Air only (adjustment not possible with the piezo scaler).



Selection via push-button ② on the foot controller.



Instruments can be operated without coolant. The dental substance can be damaged by frictional heat. Make sure that the treatment point is not overheated when you have switched off the coolant.

## General Instrument Functions

### Adjusting the Foot Controller



Take out the instrument. Activate the foot controller on the touchscreen (6).



Foot controller ON / OFF



Foot controller VARIABLE

### Adjusting the Display Mode



Take out the instrument. Activate the work display mode (7) on the touchscreen.



Display speed / intensity of the instrument while activated in bar structure



Display speed / intensity of the instrument while activated in %



Display of total speed / intensity of the instrument while activated

### Adjusting the Instrument LED



Remove the instrument



Setup settings



System



LED on



LED off



LED intensity during treatment



LED afterglow time



LED intensity during afterglow time

## Starting the Turbine

- > Remove the turbine from the instrument holder.
- > Activate the start signal at the foot controller ①.
- > Put the turbine back into its holder.
- > The last coolant settings are saved.

## Starting the Turbine (Advanced Air)



Air drive system for dental handpieces and dental air motors intended for general dental use. Removal of carious material, preparation of cavities and crowns, removal of fillings, finishing of tooth and restoration surfaces.

Full functionality is only possible with the W&H Primea Advanced Air Turbine. If another turbine or another instrument is plugged on, the Advanced Air works in standard turbine mode.



Plugging on the Roto Quick coupling and turbine (see also operating instructions of W&H Dentalwerk Bürmoos GmbH Primea Advanced Air).



- > Remove the Advanced Air turbine from the holder.
- > Activate programme configuration on the touchscreen ⑩.

### Power

In the „Power“ mode, the set speed is kept constant, even under increasing pressure on the rotating instrument, thus increasing the removal rate.

### Tactile

The „Tactile“ mode allows a reduction of the removal rate under increasing pressure on the rotating instrument.



### My Favourites - Program config



Activate programmes (up to 6 programmes possible)  
> Activate program config.



back

### Setting the speed



- > Activate the speed on the touchscreen ⑨.



Decrease / increase (setting range 60,000 to 320,000 rpm)



- > Activate the start signal at the foot controller ①.
- > Place the Advanced Air turbine in the instrument holder.
- > The last settings are saved



## Starting the Electric Motor



See also operating instructions from W&H Dentalwerk Bürmoos GmbH Electric motor EM-12L.

> Remove the electric motor from the instrument holder.



Display work mode: restoration, prosthetics and prophylaxis



### My Favourites - Program config

Preventive dentistry, conservative dentistry such as cavity preparation and prosthodontics such as crown preparation.  
Speed setting range 1,000 - 40,000 rpm.

Activate programmes (up to 6 programmes possible)

> Activate Program config.



Activate programme P1. Continue this process for the desired number of programmes (P1 to P6)



back

Setting the transmission /configuring the programme



> Activate programme configuration on the touchscreen ⑩.



Transmission ratio



Activate / deactivate transmission

Setting the speed



> Activate the speed on the touchscreen ⑨.



Decrease / increase



> Activate the start signal on the foot controller ①.

> Put the micromotor into the instrument holder.

> The last settings are saved.



You can find an application film at [www.youtube.com](http://www.youtube.com) DKL Germany.  
Video: DKL CHAIRS L2-D2 SERIES FUNCTIONS DENTAL MICROMOTOR

LINK: <https://youtu.be/M3vhRr9rLMs>

## Starting the Electric Motor



Motor left-hand rotation - The start signal is accompanied by a warning signal and the symbol is flashing. After the motor has been placed in the instrument holder, right-hand rotation is activated.



Motor right-hand rotation

### Motor endodontic function



Root canal files are subject to wear and tear. Worn files can break off during treatment. Only use the files for the service life specified by the file manufacturer.



Incorrectly selected speeds and torque values endanger the patient. Treatment errors, e.g. the breaking of a file, can occur as a result of incorrect settings. Observe the manufacturer's specifications for the file systems.



The following file logs are already provided for the motor:

- > Sendoline S5
- > Sendoline NiTi-TEE
- > Komet F360
- > Komet F6 SkyTaper
- > VDW Mtwo
- > Dentsply Pro Taper

> Remove the electric motor from the instrument holder



Switching to Endo: In the main menu, under "My favourites", ① the active file log is activated and displayed.



Display work mode: endodontics



Changing the favourites ①

- > Tap on "My favourites" ①
- > Select file programme



Auto forward

When the motor reaches the set torque threshold, it stops and immediately turns briefly in the opposite direction. This process is repeated four times.



Auto reverse

When the motor reaches the set torque threshold, it stops and immediately turns briefly in the opposite direction. Then the motor stops.

## Starting the Piezo Scaler



See also operating instructions from W&H Dentalwerk Bürmoos GmbH Piezo scaler handpiece.

> Remove piezo scaler from the instrument holder.



Display work mode: scaler



### My Favourites - Program config

Drive unit with a piezoceramic oscillation system, which sets the scaler tip into linear oscillation. The drive unit is used for the removal of supragingival calculus and subgingival concretions as well as for endodontic applications and the preparation of hard tooth structure.

Power setting range: 1-40.

Activating programmes (up to 6 programmes possible)

> Activate Program config.



Activating Programme P1. Continue this process for the desired number of programmes (P1 to P6).



back

Setting the power



> Activate power on the touchscreen ⑨.

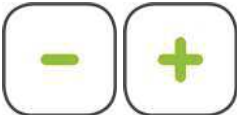

Decrease / increase



> Activate the start signal at the foot controller ①.

> Put the scaler back into its holder.

> The last settings are now saved.



> An overview of the correct power setting is provided for each type of tip.

> Only use tips approved by W&H and the corresponding tip changer or fork wrench.

> Check the wear of the tips with the enclosed tip card.

> Replace tips with visible material wear. The tips must not be bent and re-sharpened.

> Make sure that the original shape of the tip is not changed (e.g. by falling down).



You can find an application film at [www.youtube.com/watch?v=DKL](http://www.youtube.com/watch?v=DKL) Germany.  
Video: DKL CHAIRS L2-D2 SERIES FUNCTIONS PIEZO SCALER

LINK: <https://youtu.be/9ddlgJzl0Go>

## Function Syringe Luzzani Minilight



See also operating instructions of the Luzzani company for their Minilight syringe!

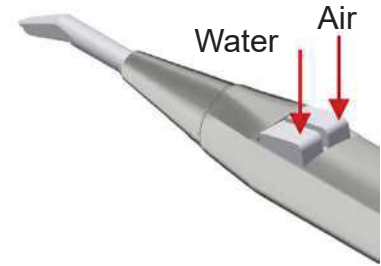
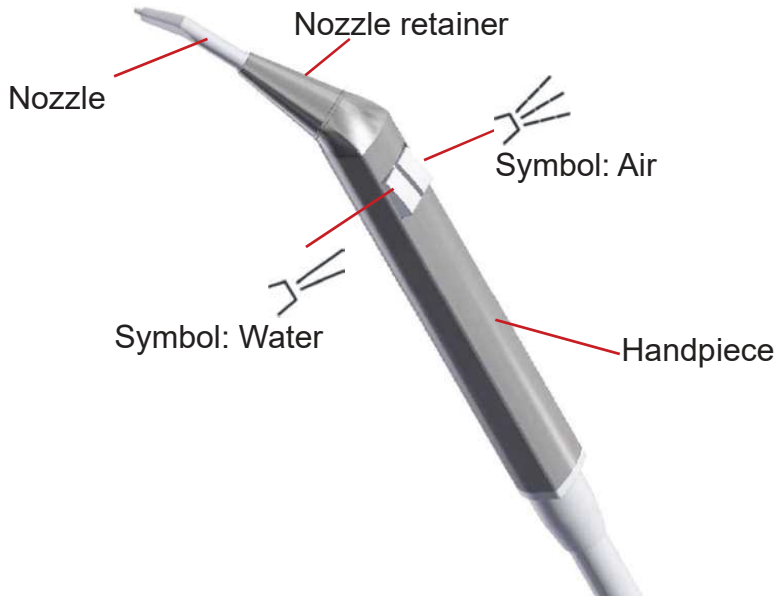

To blow water into the operating field, just press the left button on the handpiece, symbol: water. To insufflate air into the operating field, just press the right button on the handpiece, symbol: air. To blow a combination of air and water (spray), press both buttons on the handpiece at the same time.



After each use on a patient, the handpiece and tip of the syringe **MUST** be cleaned and sterilised to guarantee maximum hygiene.



Unscrew the nozzle retainer.



Withdraw the nozzle retainer.



Withdraw the nozzle.



You will find the sterilisation procedure

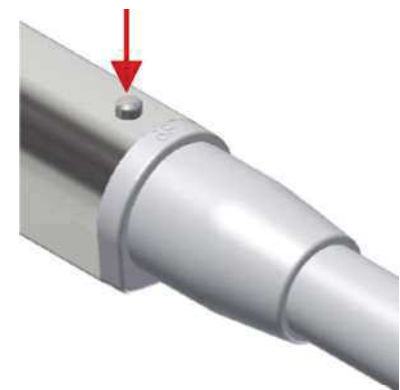

Press the pawl to release the handpiece.



Withdraw handpiece.

# Cleaning and Disinfection of the Surfaces

## Hygiene and Care of the Stainless-Steel Surfaces

The regular cleaning of stainless-steel surfaces is recommended for hygienic as well as aesthetic reasons and serves to remove grease stains or finger marks. These can be easily removed with commercially available chlorine- and acid-free stainless-steel cleaners. We recommend applying Prestan to the surface in question.

Most stainless-steel care products contain silicone oil. Using these products can make your work a lot easier. They effortlessly remove any finger marks, but do not necessarily prevent new ones. Depending on the intensity of use, the protective layer remains in place for a few days. Microfibre cloths slightly moistened with water have also proved to be very effective.

Never use abrasive agents such as scouring powder, scouring milk or steel wool as these may cause scratches. Brushed surfaces must always be wiped in the direction of the finish. For this purpose, we recommend using a microfibre cloth. After cleaning, we recommend always wiping stainless-steel surfaces dry with a lint-free cloth to remove water stains or residual cleaning agent.

## Disinfection of Stainless-Steel Surfaces

Do you put emphasis on a germ-free surface? Here, too, stainless steel proves to be extremely robust. Any commercially available chlorine-free disinfectant can be used.

Tests have shown that stainless steel is considerably easier to disinfect than other materials and even a lot less disinfectant is required in order to meet hygiene requirements.

## The Most Important Facts at a Glance:

Effective and generally safe to use on surfaces are

- Soft sponges or microfibre cloths,
- Soapy water (to remove greasy stains),
- Diluted vinegar (to remove lime),
- Sodium bicarbonate (to remove coffee stains),
- Soda (to remove tea stains),
- Alcoholic solvents (to remove glue) and
- Special stainless-steel care products (for cleaning and conservation).



Caution is called for with

- Disinfectants containing chlorine and cleaning agents containing bleach (risk of corrosion).



Never use:

- Scrubbing sponges (scratches and extraneous rust),
- Scouring powder (scratches)
- Silver polish (corrosive).



The glass display of the doctor's device can be wiped clean. DKL recommends using wipe disinfection. Only use disinfectants that do not have a protein fixing effect.

## Cleaning and Disinfection of the Instrument Holders

- Pull out the instrument holder
- Rinse off any soiling with water
- Remove any residual liquid (absorbent cloth; blow dry with compressed air)
- Disinfection with disinfectants; wipe disinfection is recommended.
- Observe the disinfectant manufacturer's instructions for use
- After manual cleaning and disinfection, a steam sterilization (packaged) in a steam sterilizer class B or S (in accordance with EN 13000) is necessary.
- Remove any soiling on the instrument panel with a damp cloth.
- Remove any residual liquid (absorbent cloth; blow dry with compressed air)
- Disinfection of the instrument panel with disinfectants; wipe disinfection is recommended.
- Observe the disinfectant manufacturer's instructions for use
- Put the instrument holders back into their respective positions.



Marking	Type of holder
T	Turbine connection
M	Micromotor
P	Piezo scaler
S	Function syringe



The supply tubes are not approved for mechanical cleaning (thermo washer disinfectant) and sterilization. Do not twist or fold the supply tubes! Do not roll up the tubes too tightly!

## Check for Oil Residues in the Turbine Return Air

Proper maintenance of the turbine handpieces will not allow oil residue to accumulate in the turbine connector. During manual maintenance, there may be excess oil in the turbine handpiece. Therefore, check the turbine connection regularly for oil residues. You will find the connection at the end of the hose below the doctor's device. If oil residue has accumulated, proceed as follows:

1. Twist off the turbine connection anti-clockwise at the end of the hose.
2. Remove the oil residues and dispose of them properly.
3. An absorbent filter wadding can be inserted into the connecting spout as a precaution.
4. Screw the turbine connection back on.

In case of recurring oil residues, check and adjust the maintenance procedure for the turbine handpieces. Automatic maintenance devices do not leave oil residue and are therefore recommended.



## Bottle Care System

The Bottle Care System is a treatment water system for the self-sufficient water supply for all the instruments and the glass filler. There is also the possibility of intensive decontamination of the service water lines in the treatment unit.

Changing the treatment water bottle on the outside of the doctor's device or on the cuspidor (depending on the version):

1. Set the flip switch (1) on the bottle holder to „off“.  
Turn the treatment water bottle (2) slightly to the left until the ventilation becomes audible.
2. Remove the treatment water bottle (2) from its holder from the left-hand side. Fill the bottle and then turn it clockwise into the bottle holder.
3. Set the flip switch (1) on the bottle holder to „on.“  
The water supply is ready for operation.

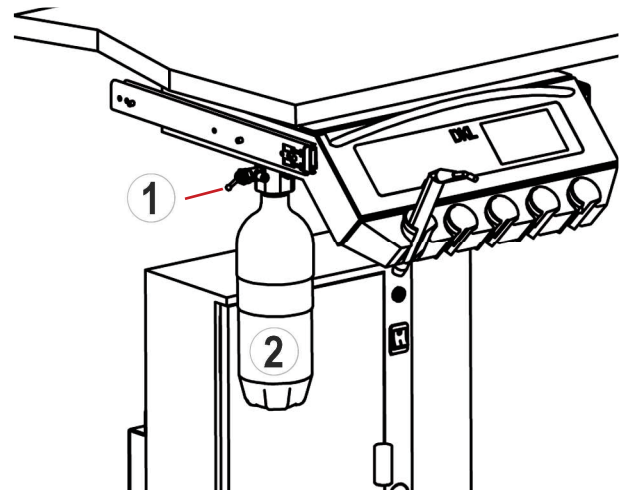

Only use bottles approved by DKL.



Use the bottles before their expiration date (see bottle). Replace the bottles at the latest if they show visible damage or when they reach their expiration date – otherwise they might burst!



Empty the treatment water bottle at the end of a working day and refill the bottle at the beginning of a working day (after recommended initial rinsing 120 sec.) with fresh operating water and DK-DOX 150 Chlorine Dioxide ready-to-use solution (1 ampoule per liter).



You can find an application film at [www.youtube.com/DKL\\_Germany](http://www.youtube.com/DKL_Germany).  
Video: DK-DOX 150 READY-TO-USE  
CHLORINE DIOXIDE SOLUTION GLASS AMPOULES FOR THE  
BOTTLE CARE SYSTEM



LINK: [https://youtu.be/Mj\\_y2YXAJKQ](https://youtu.be/Mj_y2YXAJKQ)

DK-DOX150 Chlorine dioxide Ready- to-use solution, product number 590013  
Shop: <https://dkl.de/en/DK-DOX150-Chlorine-dioxide-Ready-to-use-solution/590013>

To maintain the water quality in the Bottle Care System of DKL dental units.

### CONTENT

- 30 x 5 ml glass ampoule of chlorine dioxide solution
- 1 x ampoule opener

### APPLICATION

Open a 5 ml glass ampoule of chlorine dioxide solution using the ampoule opener and dispense it into the bottle of the Bottle Care System per 1 litre of water.

## Bottle Care System

Labelling on the bottle

**REF** Article number



Expiration date year-month

### Flushing Function with the Bottle Care System



If the treatment unit is equipped with a bottle care system, make sure that the bottle is freshly filled with water (see section Bottle Care System).



Carry out the initial rinse before starting work without chlorine dioxide solution.



Open the menu "Flushing" at the touchscreen.



Select NORMAL (daily before the first treatment).



Select QUICK (20 sec, recommended after each treatment).



Message: Take out all the instrument tubes

### Hygiene Cover

The convenient hygiene cover helps to rinse all instruments easier.



Put the hygiene cover into the cuspidor bowl. Remove all the instruments from their holders and insert them into the hygiene cover. Start with the turbine connections, micromotors and the piezo scaler tube. Then clamp the syringes into their fixtures. Only flip the lever to activate the syringe after flushing has been started on the touchscreen.

①	Turbine hose without coupling
②	Motor without contra-angle
③	Scaler hose without handpiece
④	Syringe

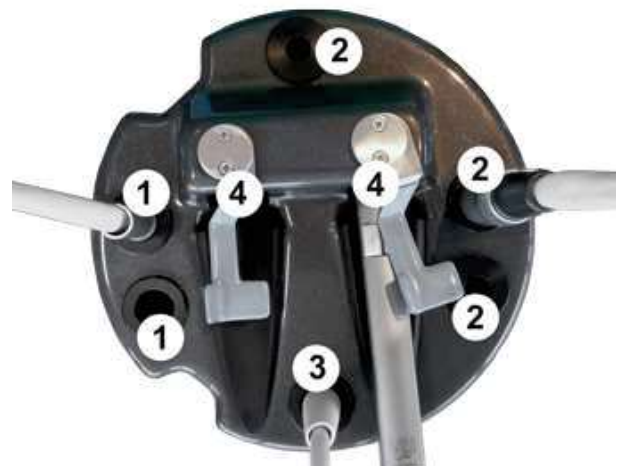



## Flushing Function with the Bottle Care System



Once all instruments have been taken out, you can confirm the flushing process.



Confirm



The flushing time (120 s) is indicated on the display.



Once all the instruments have been flushed, activate the cup filler.



Flushing times can be adjusted by the customer service in the setup. The standard flushing time is set to 120 seconds. If the device is equipped with a bottle care system, the flushing time is adjusted to the bottle content at the factory.



You can find an application film at [www.youtube.com](http://www.youtube.com) DKL Germany.

Video: FLUSHING INSTRUMENTS WITH BOTTLE CARE SYSTEM AND TOUCH SCREEN

LINK: <https://youtu.be/yS-THb6EvIQ>



**Bottle Disinfection**

For disinfection of the inside of the bottle at regular (weekly) intervals, we recommend BC-San 100. Further product information can be obtained from ALPRO Medical GmbH at [www.alpro-medical.com](http://www.alpro-medical.com).

## Intensive Flushing Function with the Bottle Care System



We recommend rehabilitating the waterways after longer periods of inactivity (holidays) or at least once a year.



You can find an application film at [www.youtube.com](http://www.youtube.com) DKL Germany.

Video: BOTTLE CARE SYSTEM WITH TOUCH SCREEN – DISINFECTION OF THE WATER SUPPLY

LINK: <https://youtu.be/1ySjnPDyuBQ>

## Documentation of instrument flushing NORMAL and INTENSIVE



The documentation of the instrument flushing NORMAL and INTENSIVE can be activated, deactivated, retrieved and exported to a USB stick via the system settings in the display in the menu SYSTEM → SYSTEM INFO (2nd page) → FLUSHING HISTORY.

## Test of the water quality at the Bottle Care System or at the Water Separation Unit (WTU)



You can find an application film at [www.youtube.com](http://www.youtube.com) DKL Germany.

Video: DKL CHAIRS L2-D2 TEST STRIPS FOR THE DK-DOX-150 DETECTION IN THE TREATMENT WATER

LINK: <https://youtu.be/3JUx-PY1xHo>

Test strips 0,1-0,4 ppm chlorine dioxide (50 pcs), product number 590008

Shop: <https://dkl.de/en/Test-strips-0-1-0-4-ppm-chlorine-dioxide-50-pcs/590008>

## Setting Media Instruments

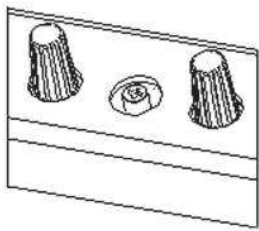

Below the doctor's device, the spray intensity can be regulated. The valve groups (3-fold) for an instrument are arranged according to the order of the instruments in the instrument holders.

The spray intensity can be adjusted with the control knobs. The operating air for the turbine or the cooling air for the motor can be adjusted with a Phillips screwdriver.

## Symbols at the Regulators



Spray air



Spray water



Operating air turbine or cooling air motor

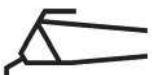

Syringe



Piezo scaler

## Maintenance and Inspection



In order to ensure the operational and functional reliability of your treatment unit and to avoid damage due to wear and tear it is necessary to perform maintenance once a year. Maintenance is carried out by an authorised technician of your specialist dealer or a DKL CHAIRS technician.

The work steps to be performed and the parts to be replaced are specified in the document "Maintenance Log". The tasks that were performed have to be entered in the maintenance log, which is part of the medical devices logbook.

## Safety Inspections



Dental units are designed in such a way that a first fault does not present a hazard to patients, operators or third parties. Therefore, it is important to detect such faults before a second fault occurs, which may result in a hazard.

For this reason, safety inspections should be carried out every 3 years to detect electrical faults in particular (e.g. faulty electrical insulation). These checks are carried out by an authorised technician of your specialist dealer or a DKL CHAIRS technician.









The work steps to be performed are specified in the document "Safety Inspections". The measured values have to be documented.

Safety inspections have to be carried out when putting your treatment unit into initial operation, after expansion or retrofitting activities on your treatment unit and after repair jobs. The safety inspections are carried out in accordance with DIN EN 62353.











The treatment unit may only be operated when the safety checks have been passed.

## Error Messages

Icon	Error description	Remedy
	Battery of the foot controller almost empty.	Change the battery in the foot controller. The message on the display can be acknowledged
	Instrument is not found.	 Call customer service.
	Several instruments have been taken out.	Check whether the instruments are properly inserted in the instrument holders.
	Pump is not recognised.	In the applications turbine, motor and scaler, the message can be acknowledged. The system switches automatically to the coolant water. With the option "Implantmed-motor" the pump is obligatory. Otherwise, the Implantmed motor cannot be used.  Call customer service.
	Voltage fluctuations.	Switch off the treatment unit. Switch the treatment unit on again after 1 minute. If the error message appears again after this restart,  Call customer service.

## Error Messages

Icon	Error description	Remedy
	Warning foot controller	> Check plug connection of the dongle.
	Warning motor	> Check plug connection of the motor > Let the motor cool down for at least 10 minutes.
	Warning USB storage device > Not enough memory > Unknown file system > Write protection is active	Plug in USB-stick with sufficient memory.
	Warning overheating	> Switch off the treatment unit. > Let the treatment unit cool down for at least 10 minutes. > Switch on the treatment unit. If the error message appears again after restarting the unit,  call customer service.
	Warning timeout	Let the micromotor cool down for at least 10 minutes.
	System error	Switch off the treatment unit. After 1 minute, switch the treatment unit on again. If the error message appears again after restarting the unit,  call customer service.

## Warranty Declaration



### 12 Months Warranty

This DKL medical product has been manufactured with the utmost care by highly qualified specialists. Multifarious checks and inspections ensure faultless performance. Please note that warranty claims will only be accepted if all the instructions in this operating manual have been observed.

DKL as the manufacturer shall be liable for material and manufacturing faults within a warranty period of 12 months from the date of purchase. Accessories and consumables (seals, filters, lamps and suction tubes) are excluded from this warranty. We do not accept liability for damages caused by improper treatment or repair work carried out by third parties that are not authorised by DKL!

Any warranty claims must be filed with the supplier or an authorised DKL service partner and the sales slip must be enclosed. Any performance of this warranty does not extend the warranty period.

To protect your warranty claims and guarantee safe operation, medical devices must be installed properly, and staff must be instructed. To be able to proof this, information for assembly, initial start-up and instructions must be documented. For this purpose, please use our L2-D2 series certificate of delivery. After putting the device into operation, please return the completed certificate to us as proof.

## Waste Disposal



Make sure that the parts that are being disposed of are not contaminated.



Observe your local and national laws, guidelines, standards and regulations for disposal.

- > Medical devices
- > Waste electrical and electronic equipment



Further information on disposal can be found at <http://dkl.de>



Disposal and recycling of DKL transport packaging is carried out within the scope of the Dual System via the local waste disposal and recycling companies.

DKL transport packaging returned by customers at their own expense is supplied by DKL to the recycling companies set up for this purpose without further costs and without reimbursement.

## **EMC - Manufacturer's Declaration for the Model L2D2-HK**

- **WARNING:** The use of accessories that do not conform to the manufacturer's specifications may result in higher interference levels and/or lower interference immunity.
- Operate the equipment in a location as far away as possible from equipment that emits electrical and magnetic disturbances. If it is necessary to operate the device in the immediate vicinity of other devices, make sure that the system functions correctly.

### **BASIC SAFETY**

BASIC SAFETY is ensured if it meets the safety requirements of the IEC 60601-1 standard, in particular the requirements against: electrical shock, mechanical hazards and hazards due to excessive temperatures.

### **ESSENTIAL PERFORMANCE**

The dental unit has no direct clinical function or essential performance according to IEC 60601-1, IEC 80601-2-60, 201.4.3 ESSENTIAL PERFORMANCE.

Performance limitations are permitted according to the following criteria. This is considered in the risk analysis of the system.

#### **Criterion A**

The dental unit will withstand the test without damage or other interference. During and after the test, the device will operate perfectly within the specified limits. Basic safety is guaranteed throughout.

#### **Criterion B**

The dental unit will withstand the test without damage or other interference. After the test, the device will operate perfectly within the specified limits. Basic safety is guaranteed throughout.

#### **Criterion C**

A temporary malfunction is permitted if the function resets itself or if it can be restored by user intervention. Basic safety is guaranteed throughout.

### **Intended operating environment**

Intended operating environments are typical professional health care facilities and areas of home health care.

### **Technical description**

This dental unit has been tested and developed to meet the EMC behaviour in the specified environment. This includes special EMC-filters to reduce the radiation of electromagnetic waves as defined in IEC 60601-1-2.

Please read and follow all technical documentation to avoid adverse events for the patient or user.

IEC STANDARD 60601-1-2:2014, 4<sup>th</sup> Edition

This device is approved for use in a specific electromagnetic environment. The customer or user of the device must ensure that it is used in an electromagnetic environment in accordance with the description given below.

Emission Measurement	Agreement	Guidelines Regarding the Electromagnetic Environment
RF-emission according to CISPR 11	Group 1	This device uses RF-energy for internal functions only. RF-emissions are therefore very low, and it is unlikely that other nearby electronic equipment will be disturbed.
RF-emission according to CISPR 11	Class B	The device is suitable for use in all environments, including residential areas, and approved for direct connection to the public low-voltage network for residential areas.
Harmonics according to IEC 61000-3-2	Class A	
Voltage fluctuations/ flicker according to IEC 61000-3-3	met	

Interference Immunity Test	IEC 60601-test level	Compliance level	Electromagnetic Environment - Guidelinesf
Electrostatic Discharge (ESD) according to IEC 61000-4-2	± 8 kV contact discharge ±2, 4, 8, 15 kV air discharge	± 8 kV contact discharge ±15 kV air discharge	The floor should be wood, concrete or tiles. If the floor is covered with synthetic material, the relative humidity should be at least 30%. Criterion B
Fast transient electrical disturbances/bursts according to IEC 61000-4-4 (only for V 300/600)	± 2 kV for mains 100 kHz repeat rate	± 2 kV for mains 100 kHz repeat rate	The quality of the mains power supply should meet the requirements for a normal commercial or clinical environment. Criterion B
Surge voltages according to IEC 61000-4-5 (only for V 300/600)	± 0,5 kV , ± 1 kV L to N ± 0,5 kV , ± 1 kV ± 2 kV L to GND	± 1 kV L to N ± 2 kV L to GND	The quality of the mains power supply should meet the requirements for a normal commercial or clinical environment. Criterion B
Voltage dips, short-term interruptions and voltage fluctuations of the mains supply lines according to IEC 61000-4-11 (only for V 300/600)	0 % UT 0°,45°,90°,135°,180°,225°,270°,315°  0 % UT 0°  0% 70 % UT  0 % UT 0%	0 % UT for 1/2 Period  1 Period  25 /30 Periods (50/60Hz)  250/300 Periods (50/60Hz) for 5 s	The quality of the mains power supply should meet the requirements for a normal commercial or clinical environment. If the user of the product requires continuous operation even with interruptions of the power supply, the product should be connected to an uninterruptible power supply.  Criterion A (max. mains voltage) Criterion B (min. mains voltage)  Criterion A (max. mains voltage) Criterion B (min. mains voltage)  Criterion A (max. mains voltage) Criterion B (min. mains voltage)  Criterion A (max. mains voltage) Criterion B (min. mains voltage)
Magnetic field at the mains frequency (50/60 Hz) according to IEC 61000-4-8	30 A/m	30 A/m	Magnetic fields at the mains frequency should have levels typical of an application in a commercial or clinical environment.

Note: UT is the alternating mains voltage prior to the application of the test level.



## Specifications for Enclosure Port Immunity

Immunity Test	Test condition	IEC 60601 level of conformity	Electromagnetic Environmental Recommendation
Radiated electromagnetic fields from high-frequency wireless communication devices IEC 61000-4-30-4-3	10 V/m 80 MHz – 2,7 GHz 80% AM 1kHz	10 V/m 80 MHz – 2,7 GHz	The quality of the main power supply should correspond to the one for a professional health care facility and be appropriate regarding the environment in areas of domestic health care. Criterion A
	385MHz (18Hz pulse modulation)	27 V/m	
	450MHz (FM+/-5KHz deviation 1kHz sine or 18Hz pulse modulation)	28 V/m	
	710MHz (217Hz PM)	9 V/m	
	745MHz (217Hz PM)	9 V/m	
	780MHz (217Hz PM)	28 V/m	
	810MHz (18Hz PM)	28 V/m	
	870MHz (18Hz PM)	28 V/m	
	930MHz (18Hz PM)	28 V/m	
	1720MHz (217Hz PM)	28 V/m	
	1845MHz (217Hz PM)	28 V/m	
	1970MHz (217Hz PM)	28 V/m	
	2450MHz (217Hz PM)	28 V/m	
	5240MHz (217Hz PM)	9 V/m	
5500MHz (217Hz PM)	9 V/m		
5785MHz (217Hz PM)	9 V/m		

Interference immunity test	IEC 60601-test level	Compliance level	Electromagnetic environment - guidelines
Conducted RF-disturbance variables according to IEC 61000-4-6 (only for V 300/600)  Radiated RF-disturbance variables and near fields from wireless communication equipment according to IEC 61000-4-3	3 Veff 150 kHz to 80 MHz  10 V/m 80 MHz to 2,7 GHz	10 Veff  10 V/m	The distance between portable or mobile RF-communications equipment and parts of the product, including cables, should not be less than the recommended protective distance calculated with the equation applicable to the transmission frequency. Recommended protective distance:  $d = 1,2\sqrt{P}$  $d = 1,2\sqrt{P}$ for 80 MHz to 800MHz  $d = 2,3\sqrt{P}$ for 800 MHz to 2.7 GHz Here P is the maximum nominal power output of the transmitter in watts (W) according to the transmitter manufacturer's specifications, and d is the recommended distance in metres (m). The field strength of permanently installed RF-transmitters, which was determined by an electromagnetic location test <sup>a</sup> should not exceed the level <sup>b</sup> permitted in any frequency range. Interference may occur in the immediate vicinity of equipment marked with the following symbol: 

Note 1: At 80 MHz and 800 MHz respectively, the larger frequency range applies.

Note 2: These guidelines may not apply to all situations. The propagation of electromagnetic waves is affected by the absorption and reflection of structures, objects, people and animals.

<sup>a</sup> The field strength of permanently installed transmitters, such as base stations for radio telephony (cordless or mobile phones), mobile radio stations, amateur radio transmitters, AM and FM radio and television transmitters, cannot theoretically be calculated with absolute accuracy. To determine the electromagnetic fields generated by fixed RF-transmitters, an electromagnetic site inspection should be carried out. If the measured field strength at the location where the device is used exceeds the permissible RF-field strength specified above, the instrument should be observed. Additional measures may be necessary, e.g. reorientation or change of location of the device.

<sup>b</sup> In the frequency range between 150 kHz and 80 MHz, the field strength should be less than 3 V/m.

## Manufacturer's Declaration - Electromagnetic Interference Immunity III

The device is approved for use in a specific electromagnetic environment.

The customer or user of the device must ensure that it is used in an electromagnetic environment as described below.

Interference Immunity Test	IEC 60601-test level	Compliance level	Electromagnetic environment – guidelines
Fluctuations in the mains frequency and mains voltage according to IEC 601-1, section 10.2.2. a (only for V 300/600)	Nominal frequency: up to 100 Hz: variations of $\pm 1$ Hz of the nominal frequency; variations of $\pm 10\%$ Hz of the nominal voltage	Nennfrequenz: bis zu 100 Hz: Schwankungen von $\pm 1$ Hz der Nennfrequenz; Schwankungen von $\pm 10\%$ Hz der Nennspannung	The quality of the mains voltage supply should meet the requirements of a normal commercial or clinical environment.

## Manufacturer's Declaration - Recommended Protective Distances between Portable or Mobile RF-Communication Equipment and the Device

The device is intended for use in an electromagnetic environment where the radiated RF-disturbance variables are checked. The customer or user of the device can help to prevent electromagnetic interference by maintaining a minimum distance between portable and mobile RF-communication equipment (transmitters) and the device in accordance with the following recommendations, which are based on the maximum output power and frequency of the communication device.

Maximum nominal power of the transmitter in watts (W)	Protective distance as a function of the frequency of the transmitter in metres (m)		
	150 kHz to 80 MHz $d = 1,2\sqrt{P}$	80 MHz to 800 MHz $d = 1,2\sqrt{P}$	800 MHz to 2,5 GHz $d = 2,3\sqrt{P}$
0,01	0,12	0,12	0,23
0,1	0,38	0,38	0,73
1	1,2	1,2	2,3
10	3,8	3,8	7,3
100	12	12	23

For transmitters with a maximum output power not specified above, the recommended safety distance  $d$  in meters (m) can be calculated with an equation from the transmitter frequency and the maximum nominal output power  $P$  of the transmitter in watts (W) based on the transmitter manufacturer's specifications.

**Note 1:** At 80 MHz and 800 MHz respectively, the larger frequency range applies.

**Note 2:** These guidelines may not apply to all situations. The propagation of electromagnetic waves is affected by the absorption and reflection of structures, objects, people and animals.

**ATTENTION:** The use of this device directly adjacent to or coupled to another unit should be avoided as it may lead to unintentional behaviour. However, if this arrangement is unavoidable, both devices must be observed to verify that they are functioning normally.

**CAUTION:** Portable RF-communication equipment (including antenna cables or external antennas) should not be closer than 30 cm to the ME-equipment or ME-system, including those cables specified by the manufacturer. Otherwise, a power limitation of the device could be caused.

## Instructions for use



**CE**  
0297

**Electric motor**  
EM-11 L / EM-12 L

**Supply hose**  
VE-10 / VE-11

# Contents

---

<b>Symbols</b> .....	4
<b>1. Introduction</b> .....	7
<b>2. Safety notes</b> .....	10
<b>3. Product description</b> .....	14
<b>4. Operation</b> .....	16
Screw on the motor .....	16
Unscrew the motor.....	17
Test run .....	19
<b>5. Hygiene and maintenance</b> .....	20
General notes .....	20
Limitations on processing.....	22
Initial treatment at the point of use.....	23
Manual cleaning.....	24
Cleaning of the optic outlet .....	25

Manual disinfection .....	26
Drying .....	27
Inspection, Maintenance and Testing .....	28
Packaging .....	29
Sterilization .....	30
Storage.....	32
<b>6. Maintenance .....</b>	<b>33</b>
<b>7. Servicing.....</b>	<b>36</b>
<b>8. W&amp;H Accessories and spare parts .....</b>	<b>38</b>
<b>9. Technical data.....</b>	<b>39</b>
<b>10. Data on electromagnetic compatibility according to IEC/EN 60601-1-2.....</b>	<b>41</b>
<b>11. Disposal.....</b>	<b>46</b>
<b>Explanation of warranty terms.....</b>	<b>47</b>
<b>Authorized W&amp;H service partners .....</b>	<b>48</b>

## Symbols

in the Instructions for use



**WARNING!**  
[risk of injury]



**ATTENTION!**  
[to prevent  
damage occurring]



General explanations,  
without risk to  
persons or objects



Do not dispose of  
with domestic waste

**R<sub>x</sub>**<sub>only</sub>

**Caution!**

Federal law restricts this device to sale by or on the order of a dentist, physician, veterinarian or with the descriptive designation of any other practitioner licensed by the law of the State in which the practitioner practices to use or order the use of the device.

# Symbols

on the motor / packaging

 CE marking  
with identification number  
of the Notified Body

 Consult Instructions for Use

 Catalogue number

 Serial number

 Humidity limitation

 DataMatrix Code  
for product information  
including UDI (Unique  
Device Identification)

 Sterilizable up to the  
stated temperature

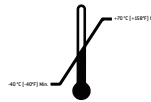
 Permitted  
temperature range

 UL Component Recognition  
Mark indicates compliance  
with Canadian and U.S.  
requirements

 Data structure in  
accordance with  
Health Industry Bar Code





 Date of manufacture

 Medical Device

 Manufacturer

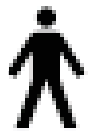
## Symbols

on the supply hose

	CE marking with identification number of the Notified Body		Type B applied part (not suitable for intracardiac application)		Medical Device
	Catalogue number		Serial number		



# 1. Introduction

---

Customer satisfaction has absolute priority in the W&H quality policy. This medical device has been developed, manufactured and subjected to final inspection according to legal regulations, quality and industry standards.

## **For your safety and the safety of your patients**

Prior to initial use please read the Instructions for use. These explain how to use your medical device and guarantee a smooth and efficient operation.



Observe the safety notes.

## **Intended use**

Electrical drive, including the supply of cooling media, for dental transmission instruments used in the field of preventive dentistry, restorative dentistry such as cavity preparation and prosthodontics such as crown preparation.



Misuse may damage the medical device and hence cause risks and hazards for patient, user and third parties.

### **Qualifications of the user**

We have based our development and design of the medical device on the dentists, dental hygienists, dental employees (prophylaxis) and dental assistants target group.

### **Responsibility of the manufacturer**

The manufacturer can only accept responsibility for the safety, reliability and performance of the medical device when it is used in compliance with the following directions:

- > The medical device must be used in accordance with these Instructions for Use.
- > The medical device has no components that can be repaired by the user.  
Modifications or repairs must only be undertaken by an authorized W&H service partner (see page 48).

## **Skilled application**

The medical device is intended only for skilled application according to the intended use as well as in compliance with the valid health and safety at work regulations, the valid accident prevention regulations and in compliance with these Instructions for Use.

The medical device should be prepared for use and maintained by staff who have been trained in procedures for infection control, personal safety and patient safety.

Improper use, (e.g., through poor hygiene and maintenance), non-compliance with our instructions or the use of accessories and spare parts which are not approved by W&H, invalidates all claims under warranty and any other claims.



Any serious incident that has occurred in relation to the medical device should be reported to the manufacturer and the competent authority!

## 2. Safety notes

---



- > Before using the medical device for the first time, store it at room temperature for 24 hours.
- > Always ensure the correct operating conditions and cooling function.
- > Always ensure that sufficient and adequate cooling is delivered and ensure adequate suction.
- > In case of coolant supply failure, the medical device must be stopped immediately.
- > Check the medical device for damage and loose parts each time before using.
- > Do not operate the medical device if it is damaged.
- > Use only the filtered, oil-free and cooled air supplied by dental compressors for drive air.
- > Perform a test run each time before using.
- > Do not look directly into the light source.
- > Never touch the patient and the electrical contacts on the medical device simultaneously.



- > The medical device is not approved for operation in potentially explosive atmospheres.
- > The operation of the medical device is permitted only on supply units which correspond to the standards IEC 60601-1 (EN 60601-1) and IEC 60601-1-2 (EN 60601-1-2).



- > Moisture in the medical device may cause a malfunction. (Risk of short circuit)
- > The medical product is lubricated for life and therefore should not be lubricated.
- > Do not twist, kink or squeeze the supply hose (risk of damage).
- > Replace damaged or leaking O-rings immediately.
- > The medical device is tailored to the W&H supply hose and the W&H control electronics and must therefore only be used with W&H products. Using other components could lead to deviating parameters or even the destruction of the system.



### **Risks due to electromagnetic fields**

The functionality of implantable systems, such as cardiac pacemakers and implantable cardioverter defibrillators (ICD) can be affected by electric, magnetic and electromagnetic fields.

- > Find out if patient and user have implanted systems before using the medical device and consider the application.
- > Weigh the risks and benefits.
- > Keep the medical device away from implanted systems.
- > Do not place the motor on the patient's body.
- > Make appropriate emergency provisions and take immediate action on any signs of ill-health.
- > Symptoms such as raised heartbeat, irregular pulse and dizziness can be signs of a problem with a cardiac pacemaker or ICD.



### **Rotational energy**

Fast deceleration of the bur can, at times, cause the selected torque to be temporarily exceeded, compared to the value set, as a result of the rotational energy stored in the drive system.



### **Transmission instruments**

- > Follow the directions and safety notes in the Instructions for Use of the transmission handpieces.
- > Only use transmission instruments with an ISO 3964 (DIN 13940) compatible coupling system and manufacturer approved transmission instruments.
- > Follow the directions of the manufacturer of transmission handpieces with reference to transmission ratio, maximum speed and maximum torque.



### **Hygiene and maintenance prior to initial use**

- > The medical device is sealed in PE film and not sterilized when delivered.
- > The PE film and the packaging are non-sterilizable.
  
- > Clean and disinfect the medical device.
- > Sterilize the medical device.

### 3. Product description

Motor

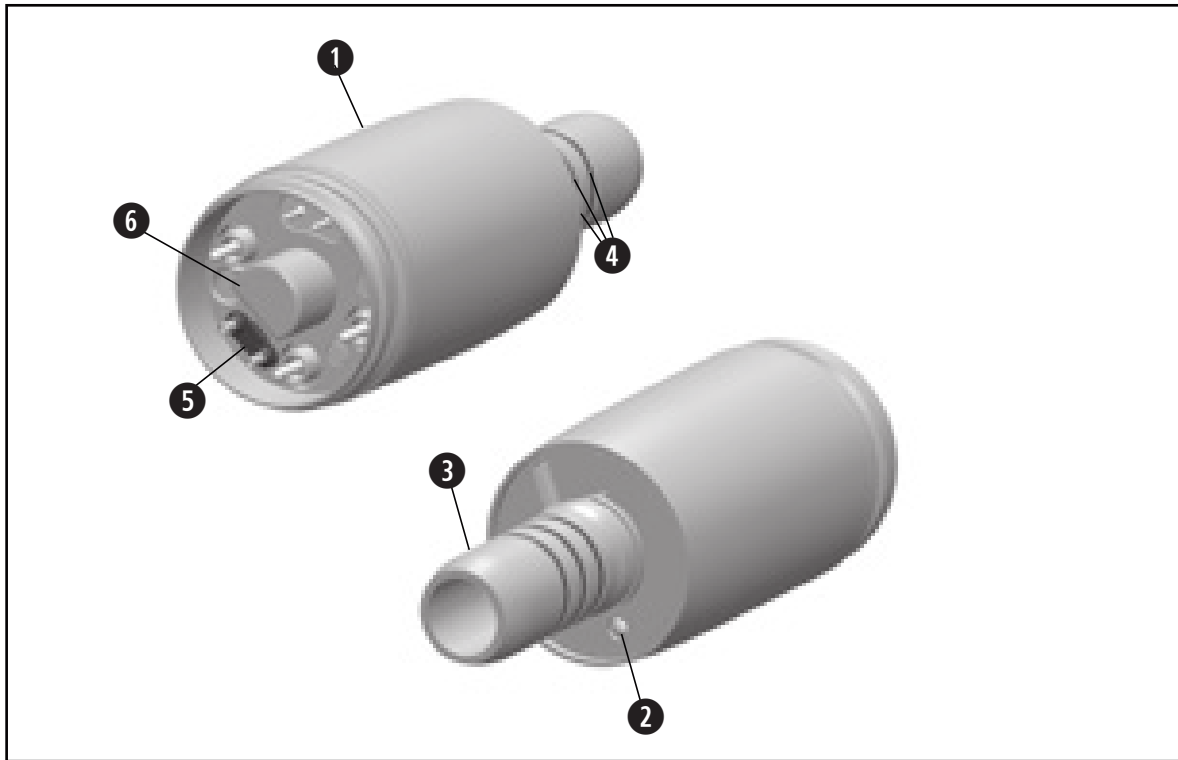

- ① Motor shealt
- ② LED
- ③ Connection for instruments  
as per ISO 3964
- ④ O-rings
- ⑤ Seal
- ⑥ Alignment pin (only for EM-11 L)



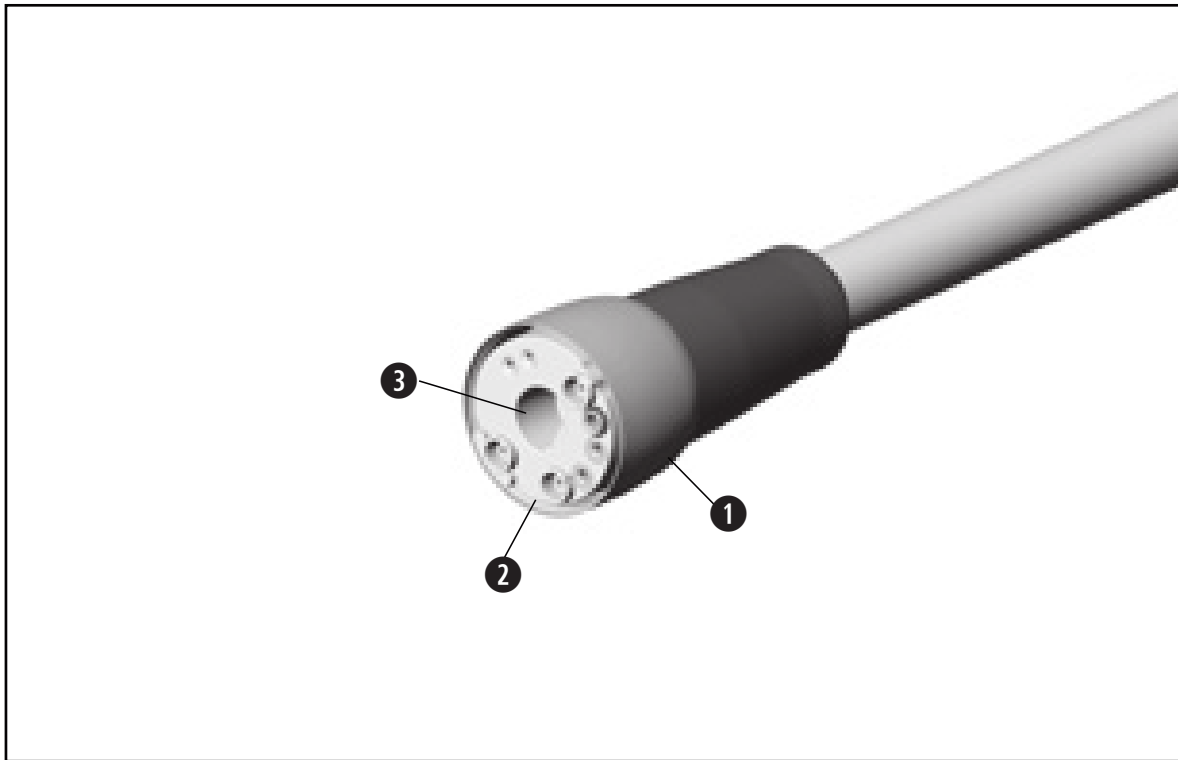

- ① Tubing sleeve
- ② Connection
- ③ Alignment hole (only for EM-11 L)

## 4. Operation

Screw on the motor

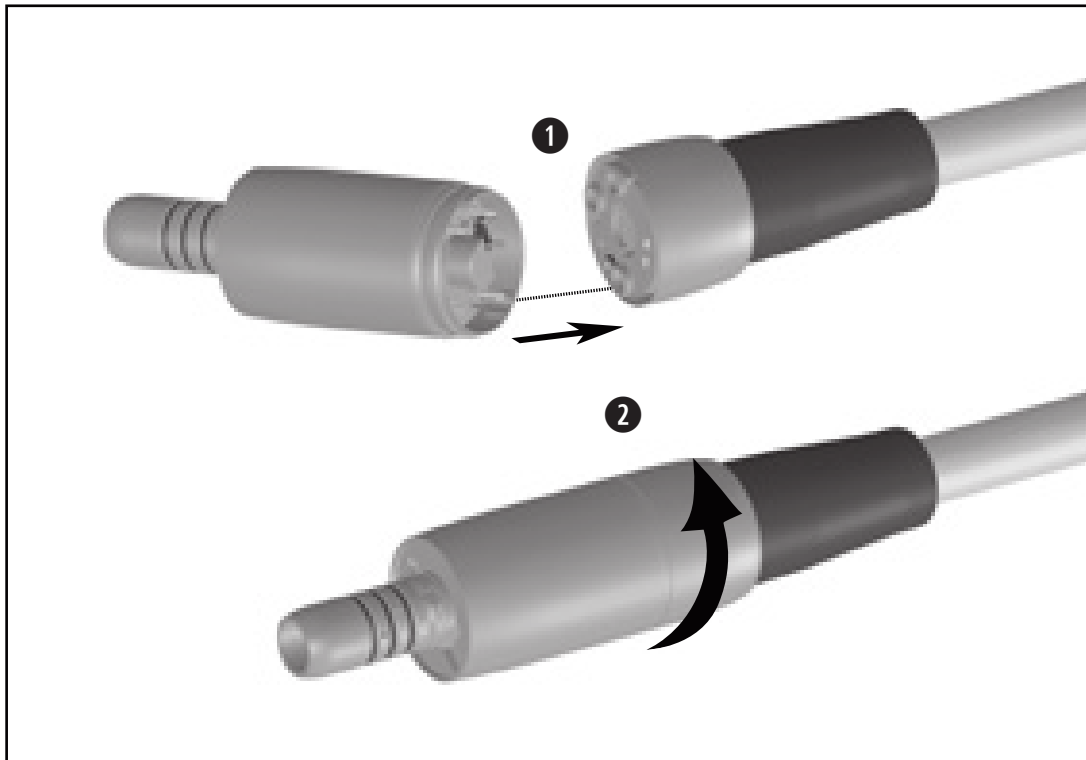

Do not assemble or remove the medical device during operation!

- 1 Push the motor onto the supply hose.  
Note the alignment aids
- 2 Screw the tubing sleeve and the motor together.

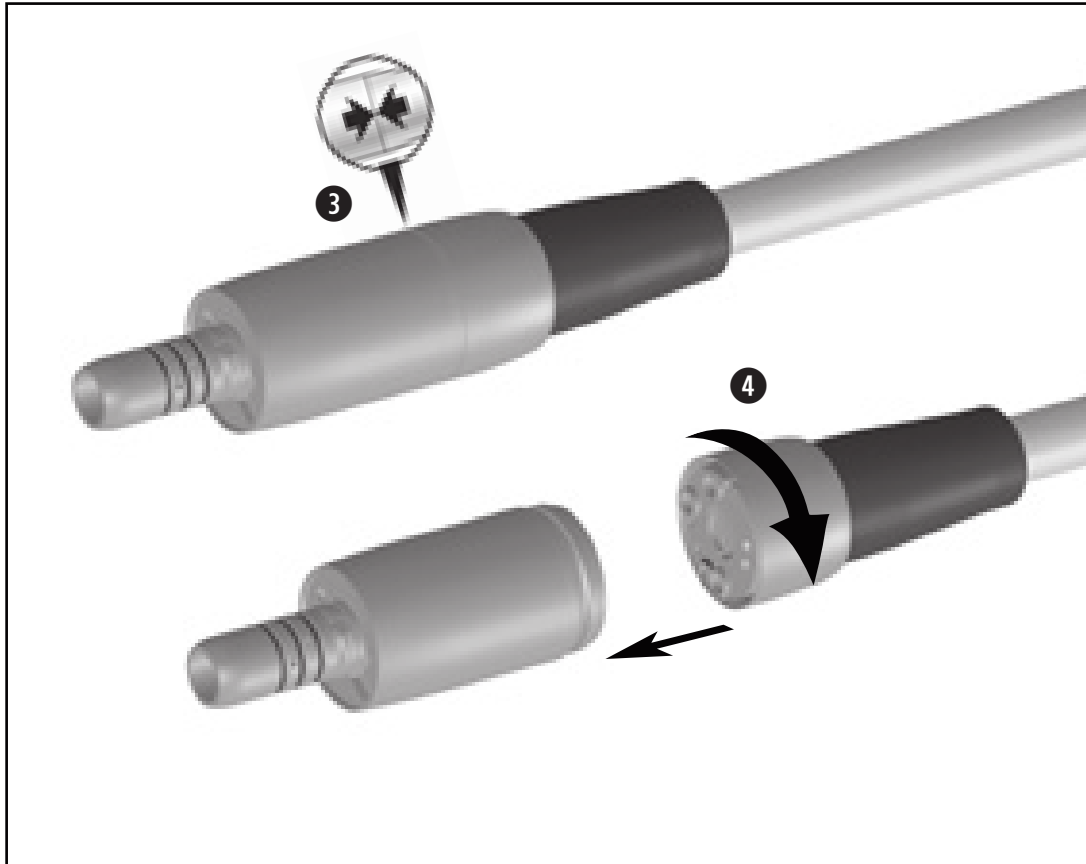

- 3 Carry out a visual inspection. The motor and the tubing sleeve coupling must sit flush to one another.

 Verify full engagement.

#### Unscrew the motor

- 4 Unscrew the supply hose from the motor.

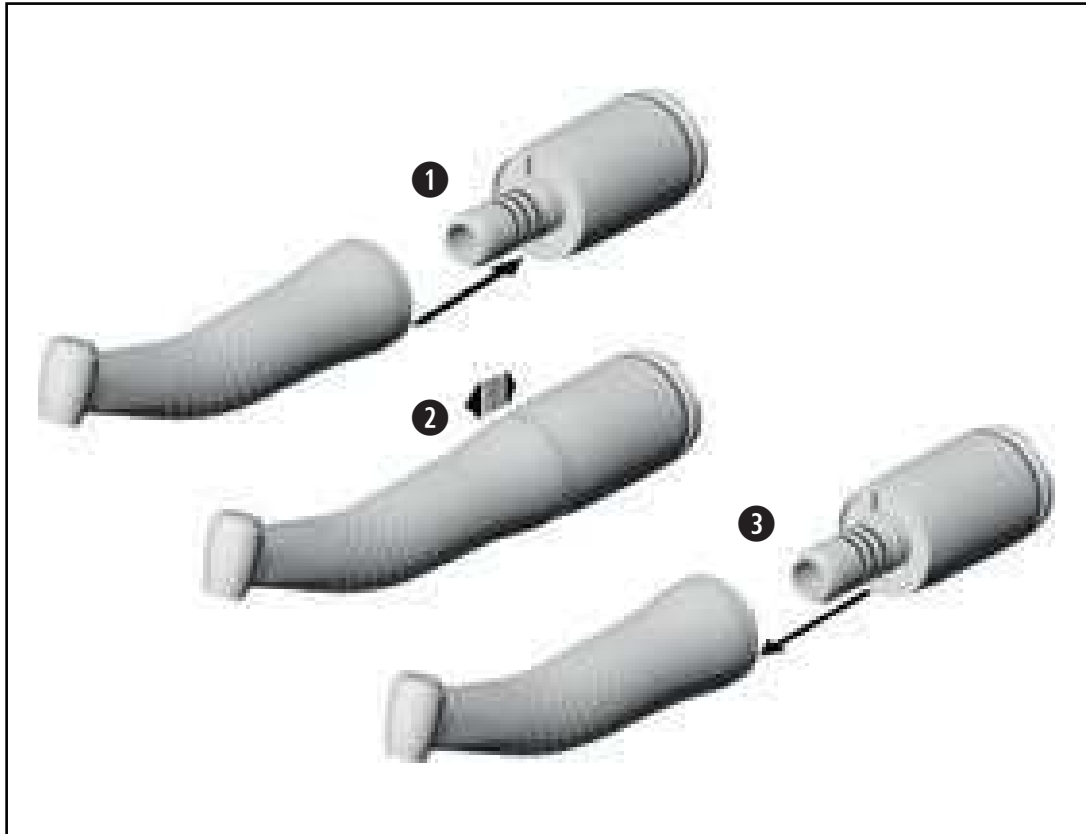

## Assembly and removal of transmission instruments



Do not assemble or remove the medical device during operation!

- 1 Push the transmission instrument onto the motor and turn it until it engages audibly.



- 2 Verify full engagement.

- 3 Remove the transmission instrument from the motor.

## Test run



> Do not hold the medical device at eye level.

> Start the medical device using the attached transmission instrument.



In the event of operating malfunctions (e.g., vibrations, unusual noise, overheating, coolant failure or leakage) **stop the medical device immediately** and contact an authorized W&H service partner.

## 5. Hygiene and maintenance

### General notes



Follow your local and national laws, directives, standards and guidelines for cleaning, disinfection and sterilization.



- > Wear protective clothing, safety glasses, face mask and gloves.
- > Remove the transmission instrument from the medical device.
- > Use only oil-free, filtered compressed air with a maximum operating pressure of 3 bar for manual drying.



- > The motor is not approved for automated processing in a washer-disinfector.
- > Note the dental manufacturer´s reprocessing instructions for the supply hose.
- > The supply hose is not approved for automated processing in a washer-disinfector and sterilization.



### **Cleaning agents and disinfectants**

- > Read the notes, follow the instructions and heed the warnings provided by the manufacturers of cleaning agents and/or disinfectants.
- > Use only detergents which are intended for cleaning and/or disinfecting medical devices made of metal and plastic.
- > It is imperative to comply with the concentrations and exposure times specified by the manufacturer of the disinfectant.
- > Use disinfectants which have been tested and found effective by the Verbund für Angewandte Hygiene e.V. (VAH = Association for Applied Hygiene), the Österreichischen Gesellschaft für Hygiene, Mikrobiologie und Präventivmedizin (ÖGHMP = Austrian Society for Hygiene, Microbiology and Preventive Medicine), the Food and Drug Administration (FDA) and the U.S. Environmental Protection Agency (EPA).



The user is responsible for validating its process if the specified cleaning agents and disinfectants are not available.

 The product lifetime and the medical device's ability to operate correctly are mainly determined by mechanical stress during use and chemical influences due to processing.

- > Send worn or damaged medical devices and/or medical devices with material changes to an authorized W&H service partner.

 **Processing cycles**  
> We recommend a regular service for the W&H motor after 500 processing cycles or one year.





- > Remove the motor from the supply hose.
- > Clean the medical device immediately after every treatment.



Note that the disinfectant used during pre-treatment is only for personal protection and cannot replace the disinfectant step after cleaning.



Do not place the medical device in liquid disinfectant or in an ultrasonic bath.

- > Clean the medical device under running tap water (< 35 °C / < 95 °F).
- > Rinse and brush off all internal and external surfaces.
- > Remove any liquid residues using compressed air.

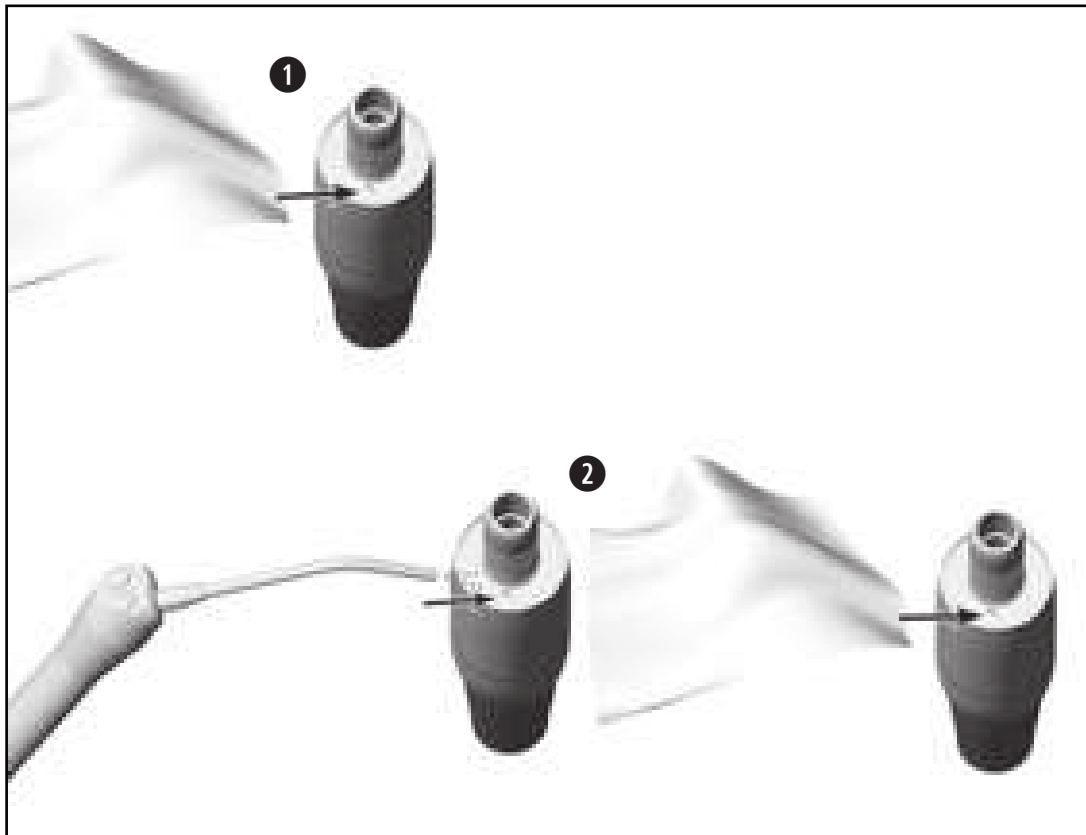

## Cleaning of the optic outlet



Avoid scratching the light source!

- 1 Wash the optic outlet with cleaning fluid and a soft cloth.
- 2 Blow the optic outlet dry with compressed air or dry it carefully with a soft cloth.



Carry out a visual inspection after each cleaning process. Do not use the medical device if the light source is damaged and contact an authorized W&H service partner.



> W&H recommends wiping down with disinfectant.



Evidence of the medical device's basic suitability for effective manual disinfection was provided by an independent test laboratory using the disinfectants "mikrozid® AF wipes" (Schülke & Mayr GmbH, Norderstedt) and "CaviWipes™" (Metrex).



- > Ensure that the medical device is completely dry internally and externally after cleaning and disinfection.
- > Remove liquid residues using compressed air.

### Inspection



- > Check the medical device after cleaning and disinfection for damage, visible residual soiling and surface changes.
- > Reprocess any medical devices that are still soiled.
- > Sterilize the motor following cleaning, disinfection.



Pack the medical device in sterilization packaging that meet the following requirements:

- > The sterilization package must meet the applicable standards in respect of quality and use and must be suitable for the sterilization method.
- > The sterilization package must be large enough for the sterilization goods.
- > The filled sterilization package must not be under tension.



W&H recommends sterilization according to EN 13060, EN 285 or ANSI/AAMI ST55.



- > Read the notes, follow the instructions and heed the warnings provided by the manufacturers of steam sterilizers.
- > The program selected must be suitable for the motor.

### Recommended sterilization procedures

- > “Dynamic-air-removal prevacuum cycle” (type B) / “Steam-flush pressure-pulse cycle“ (type S)\*/\*\*  
134°C (273°F) for at least 3 minutes, 132°C (270°F) for at least 4 minutes
- > “Gravity-displacement cycle” (type N)\*\*  
121°C (250°F) for at least 30 minutes
- > Maximum sterilization temperature 135°C (275°F)





Evidence of the medical device's basic suitability for effective sterilization was provided by an independent test laboratory using the LISA 517 B17L\* steam sterilizer (W&H Sterilization S.r.l., Brusaporto (BG)), the Systec VE-150\* steam sterilizer (Systec) and the CertoClav MultiControl MC2-S09S273\*\* steam sterilizer (CertoClav GmbH, Traun).

“Dynamic-air-removal prevacuum cycle” (type B):	134°C (273°F) – 3 minutes*, 132°C (270°F) – 4 minutes*/**
“Steam-flush pressure-pulse cycle” (type S):	134°C (273°F) – 3 minutes*, 132°C (270°F) – 4 minutes*/**
“Gravity-displacement cycle” (type N):	121°C (250°F) – 30 minutes**

Drying times:

“Dynamic-air-removal prevacuum cycle” (type B):	132°C (270°F) – 30 minutes**
“Steam-flush pressure-pulse cycle” (type S):	132°C (270°F) – 30 minutes**
“Gravity-displacement cycle” (type N):	121°C (250°F) – 30 minutes**

\* EN 13060, EN 285, ISO 17665

\*\* ANSI/AAMI ST55 , ANSI/AAMI ST79

-  > Store sterile goods dust-free and dry.
- > The shelf life of the sterile goods depends on the storage conditions and type of packaging.

## 6. Maintenance

### Exchanging the motor O-rings

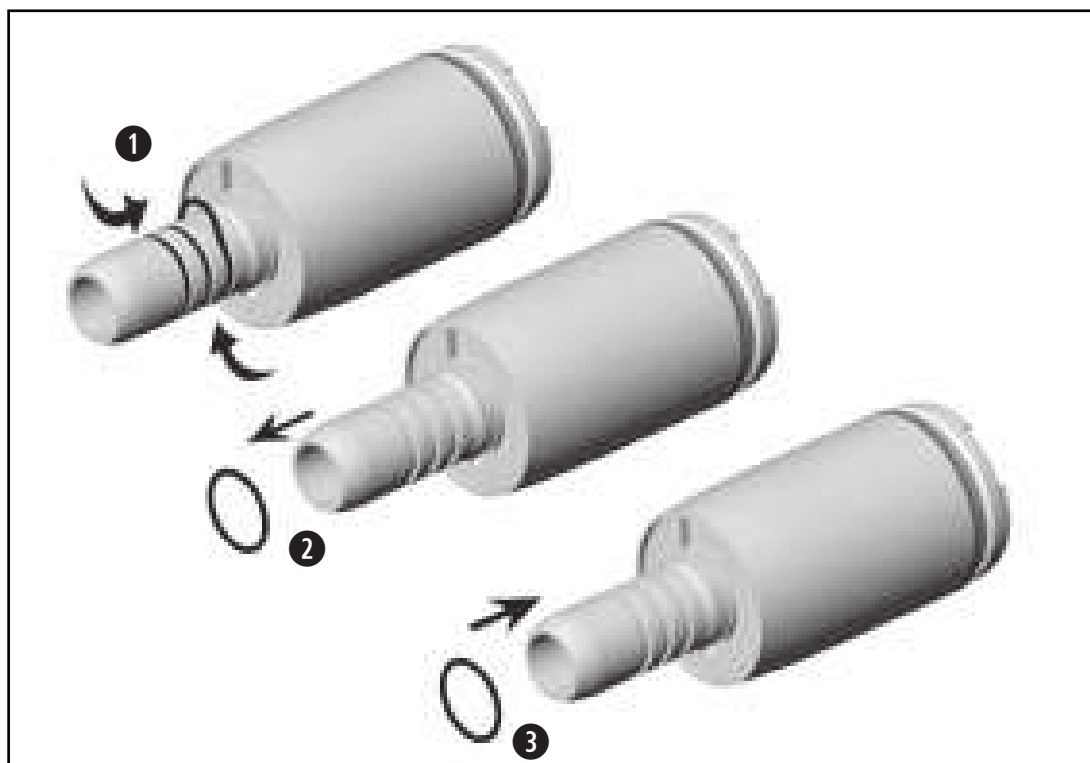

Replace damaged or leaking O-rings immediately. Do not use sharp tools!

- 1 Squeeze the O-ring together between thumb and forefinger to form a loop.
- 2 Pull off the O-rings.
- 3 Slide on the new O-rings.



Always change all three O-rings at the same time in order to ensure the tightness of the motor.

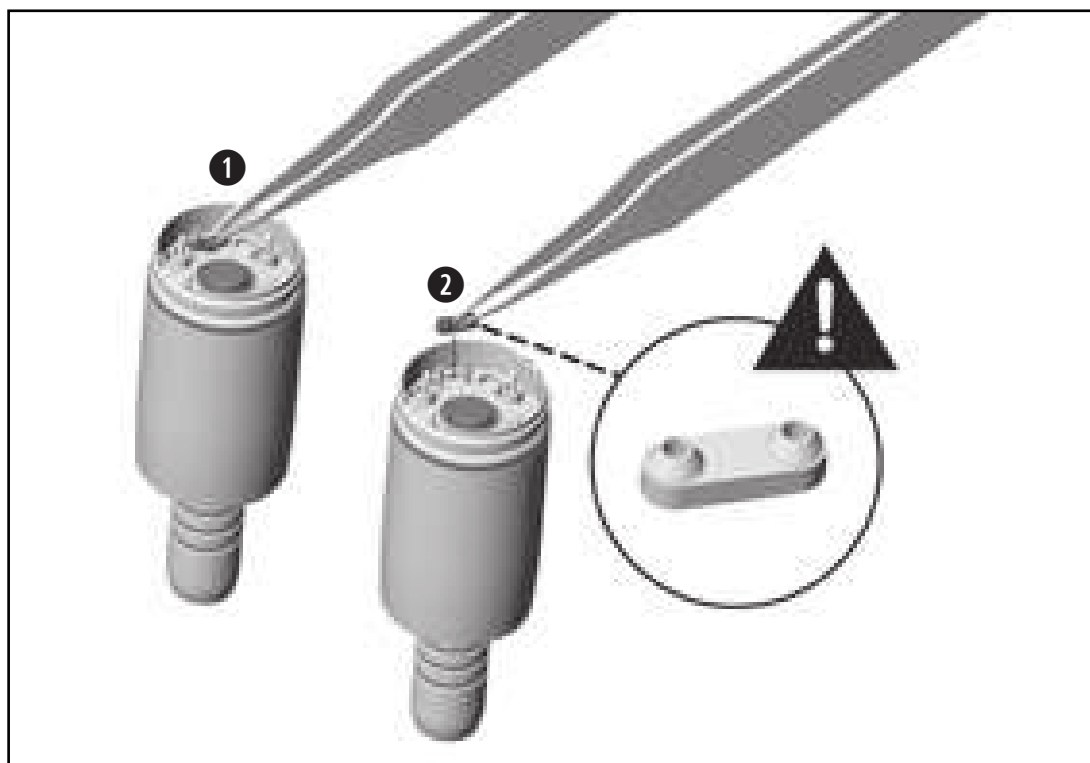

- 1 Lift up the seal with the tip of a pair of tweezers. Remove the seal.
- 2 Carefully insert the new seal.



Pay attention to the positioning of the seal.

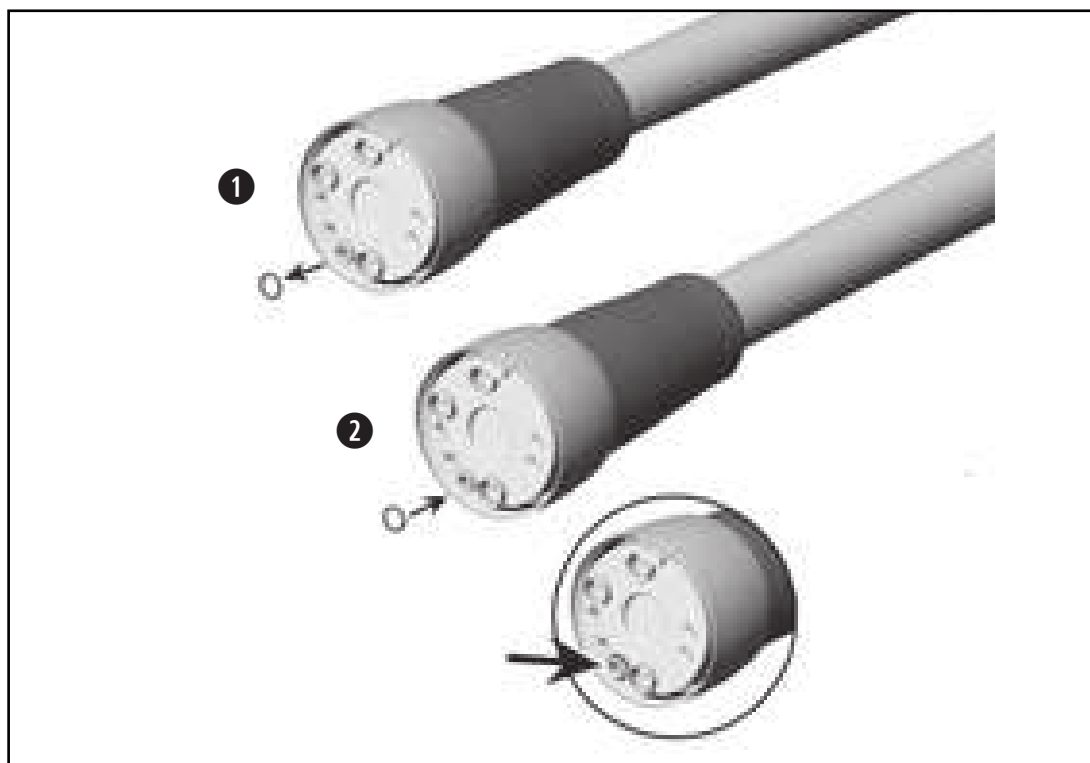

Replace damaged or leaking O-rings immediately. Do not use sharp tools!

- 1 Pull off the O-ring.
- 2 Slide on the new O-ring.

## 7. Servicing

---



### **Periodic inspection**

Regular periodic inspection of the function and safety of the medical device is necessary and should be carried out at least once every three years, unless shorter intervals are prescribed by law. The periodic inspection covers the complete medical device and must only be performed by an authorized service partner.

## Repairs and returns

In the event of operating malfunctions immediately contact an authorized W&H service partner.  
Repairs and maintenance work must only be undertaken by an authorized W&H service partner.



> Ensure that the medical device has been completely processed before returning it.

## 8. W&H Accessories and spare parts

---



Use only original W&H accessories and spare parts or accessories approved by W&H.

**Suppliers:** W&H service partners

01862300	Motor O-rings (3 pcs)
06893400	Seal (1 pcs)
07072400	Supply hose O-ring (1 pcs)



## 9. Technical data

Motor	EM-11 L	EM-12 L
Approved supply hose	VE-11	VE-10 / VE-11
Transmission instrument according to standard	ISO 3964	
Direction of rotation	forward/reverse	
Speed range	2,000 – 40,000 rpm	100 – 40,000 rpm
Maximum torque at the motor	3 Ncm	
Adjustment cooling air	6 – 8 NI/min	
Air coolant pressure* The air coolant pressure has to be higher than the water coolant pressure	0.5 – 3.0 bar	
Water coolant volume at (0,5 bar)	> 60 ml/min	
Water coolant pressure*	0.5 - 3.0 bar	

\* Adjust the actual pressure with an attachment in place.

## Technical data

Supply hose	VE-10	VE-11
Approved electric motor	EM-12 L	EM-11 L / EM-12 L
Drive air respective cooling air at 250 kPa (2,5 bar)	> 8 NI/min	
Spray air at 250 kPa (2,5 bar)	> 8 NI/min	
Spray water at 200 kPa (2,0 bar)	> 200 ml/min	
Maximum pressure	400 kPa (4.0 bar)	

## **10. Data on electromagnetic compatibility according to IEC/EN 60601-1-2**

---

### **Operating environment and EMC warning notes**

This medical device is neither life-sustaining nor coupled to the patient. It is suitable for operation both in domestic healthcare and in facilities used for medical purposes except rooms/areas, in which EMC interference of high intensity may occur.

The customer and/or the user should assure that this medical device is set up and used in an environment of the specified type and/or in accordance with the specifications of the manufacturer. This medical device uses RF energy only for its internal functions.

No special precautions are necessary to maintain the basic safety and essential performance of this medical device.

### **Essential performance**

This medical device has no critical functions and therefore does not have any essential performance features.



### **Portable RF communication devices**

Portable RF communications equipment (including peripherals such as antenna cables and external antennas) should be used no closer than 30 cm (12 inches) to the medical device. Otherwise, degradation of the performance of this medical device could result.



W&H guarantees the compliance of the device with the EMC requirements only when used with original W&H accessories and spare parts. The use of accessories and spare parts not approved by W&H can lead to an increased emission of electromagnetic interference or to a reduced resistance against electromagnetic interference.



Use of this medical device adjacent to or stacked with other equipment should be avoided because it could result in improper operation. If such use is necessary, this medical device and the other equipment should be observed to verify that they are operating normally.



The medical device is not intended for use in the vicinity of HF surgical devices.

## Results of the electromagnetic tests

Requirement	Class / Test Level*
<b>Electromagnetic emissions</b>	
Mains terminal disturbance voltage (Conducted Emissions) CISPR 11/EN 55011 [150 kHz – 30 MHz]	Group 1 Class B
Electromagnetic radiation disturbance (Radiated Emissions) CISPR 11/EN 55011 [30 MHz – 1000 MHz]	Group 1 Class B
Harmonic distortion IEC/EN 61000-3-2	Class A
<b>Immunity to electromagnetic interference</b>	
Electrostatic discharge (ESD) IEC/EN 61000-4-2	Contact discharge: $\pm 8$ kV Air discharge: $\pm 2/4/8/15$ kV
Radiated RF electromagnetic field IEC/EN 61000-4-3 [80 MHz – 2,7 GHz]	10 V/m

\* There are no deviations or simplifications to IEC 60601-1-2.

Proximity fields from RF wireless communications equipment IEC/EN 61000-4-3	385 MHz	27 V/m
	450 MHz	28 V/m
	710 / 745 / 780 MHz	9 V/m
	810 / 870 / 930 MHz	28 V/m
	1720 / 1845 / 1970 MHz	28 V/m
	2450 MHz	28 V/m
	5240 / 5500 / 5785 MHz	9 V/m
Electrical fast transient/burst IEC/EN 61000-4-4 Electrical cables Input and output cables	±2 kV ±1 kV	
Conducted disturbances induced by RF fields IEC/ EN 61000-4-6	3 V 6 V in ISM bands 6 V in amateur radio bands	
Power frequency magnetic field EN 61000-4-8	30 A/m	



## Temperature information

Temperature of the medical device on the operator side: maximum 56°C (133°F)

## Ambient conditions

Temperature during storage and transport:

-40°C to +70°C (-40°F to +158°F)

Humidity during storage and transport:

8% to 80% (relative), non-condensing

Temperature during operation:

+10°C to +35°C (+50°F to +95°F)

Humidity during operation:

15% to 80% (relative), non-condensing

Altitude:

up to 3,000 m above sea level

## 11. Disposal

---



Ensure that the parts are not contaminated on disposal.



Follow your local and national laws, directives, standards and guidelines for disposal.

- > Medical device
- > Waste electrical equipment
- > Packaging



# Explanation of warranty terms

This medical device has been manufactured with great care by highly qualified specialists. A wide variety of tests and controls guarantee faultless operation. Please note that claims under warranty can only be validated when all the directions in the Instructions for use have been followed.

**As manufacturer, W&H is liable for material or manufacturing defects within a warranty period of 24 months from the date of purchase.**

**24 months for the motor EM-11 L / EM-12 L**

**12 months for the supply hose VE-10 / VE-11**

**Accessories and consumables are excluded from the warranty**

We accept no responsibility for damage caused by incorrect handling or by repairs carried out by third parties not authorized to do so by W&H!

Claims under warranty accompanied by proof of purchase, must be sent to the vendor or to an authorized W&H service partner. The provision of service under warranty extends neither the warranty period nor any other guarantee period.

# 24/12 months warranty

## Authorized W&H service partners

---

Find your nearest authorized W&H service partner at <http://wh.com>  
Simply go to the menu option “Service“ for full details.

Or simply scan the QR code.





## **Manufacturer**

**W&H Dentalwerk Bürmoos GmbH**

**Ignaz-Glaser-Straße 53, 5111 Bürmoos, Austria**

**t +43 6274 6236-0,  
office@wh.com**

**f +43 6274 6236-55  
wh.com**

**Form-Nr. 50797 AEN  
Rev. 003 / 20.10.2021  
Subject to alterations**

## Instructions for use



CE  
0297



proxeo<sup>ULTRA</sup>

**Handpiece**  
PB-5 L, PB-5 L S, PB-5 L Q

# Contents

---

- Symbols**..... 4
  - in the Instructions for use ..... 4
  - on the medical device ..... 5
  - packaging..... 6
- 1. Introduction** ..... 7
- 2. Safety notes** ..... 10
- 3. Product description**..... 15
- 4. Operation**..... 16
  - Assembly/Removal ..... 16
  - Changing the tip ..... 17
  - Test run ..... 20
- 5. Hygiene and maintenance** ..... 21
  - General notes ..... 21
  - Limitations on processing..... 23

Initial treatment at the point of use.....	24
Manual cleaning.....	25
Manual disinfection.....	29
Automated cleaning and disinfection.....	30
Drying.....	31
Inspection, Maintenance and Testing.....	32
Packaging.....	34
Sterilization.....	35
Storage.....	38
<b>6. Exchanging the supply hose O-rings.....</b>	<b>39</b>
<b>7. Servicing.....</b>	<b>40</b>
<b>8. W&amp;H Accessories and spare parts.....</b>	<b>41</b>
<b>9. Technical data.....</b>	<b>42</b>
<b>10. Disposal.....</b>	<b>44</b>
<b>Explanation of warranty terms.....</b>	<b>45</b>
<b>Authorized W&amp;H service partners.....</b>	<b>47</b>

## Symbols

in the Instructions for use



**WARNING!**  
(risk of injury)



**ATTENTION!**  
(to prevent  
damage occurring)



General explanations,  
without risk to  
persons or objects



Do not dispose of  
with domestic waste



Type B applied part  
(not suitable for  
intracardiac application)



# Symbols

on the medical device

 CE marking with identification number of the Notified Body

 DataMatrix Code for product information including UDI (Unique Device Identification)

 HIBC Data structure in accordance with Health Industry Bar Code

 REF Catalogue number

 Thermo washer disinfectable

Thread system:

 Q-Link

 W&H

 Satelec

 SN Serial number

 135°C  
Sterilizable up to the stated temperature

 Date of manufacture

 Suitable for people with pacemakers or implanted defibrillators

## Symbols

packaging



CE marking  
with identification number  
of the Notified Body

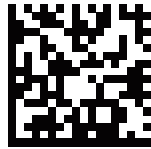

DataMatrix Code  
for product information  
including UDI (Unique  
Device Identification)



Data structure in  
accordance with  
Health Industry Bar Code



Caution! According to Federal law, this medical device may only be sold by or on the order of a dentist, physician or any other medical practitioner licensed by the law of the State in which he or she practices and intends to use or order the use of this medical device.

# 1. Introduction

---

Customer satisfaction has absolute priority in the W&H quality policy. This medical device has been developed, manufactured and subjected to final inspection according to legal regulations, quality and industry standards.

## **For your safety and the safety of your patients**

Prior to initial use please read the Instructions for use. These explain how to use your medical device and guarantee a smooth and efficient operation.



Observe the safety notes.

## **Intended use**

Drive unit with a piezoceramic oscillating system, which moves the tip in a linear oscillation. The drive unit is used for the removal of supragingival calculus and subgingival concretions and for endodontics application and preparation of tooth enamel.



Misuse may damage the medical device and hence cause risks and hazards for patient, user and third parties.

## **Qualifications of the user**

We have based our development and design of the medical device on the dentists, dental hygienists, dental employees (prophylaxis) and dental assistants target group.



### **Production according to EU Directive**

The medical device meets the requirements of Directive 93/42/EEC.

## **Responsibility of the manufacturer**

The manufacturer can only accept responsibility for the safety, reliability and performance of the medical device when it is used in compliance with the following directions:

- > The medical device must be used in accordance with these Instructions for use.
- > The medical device has no components that can be repaired by the user.
- > Modifications or repairs must only be undertaken by an authorized W&H service partner (see page 47).
- > Unauthorized opening of the medical device invalidates all claims under warranty and any other claims.

### **Skilled application**

The medical device is intended only for skilled application according to the intended use as well as in compliance with the valid health and safety at work regulations, the valid accident prevention regulations and in compliance with these Instructions for use.

The medical device should be prepared for use and maintained by staff who have been trained in procedures for infection control, personal safety and patient safety.

Improper use, unauthorized assembly, modification or repair to the medical device, non-compliance with our instructions or the use of accessories and spare parts which are not approved by W&H, invalidates all claims under warranty and any other claims.

## 2. Safety notes

---



- > Before using the medical device for the first time, store it at room temperature for 24 hours.
- > Always ensure the correct operating conditions and cooling function.
- > Always ensure that sufficient and adequate cooling is delivered and ensure adequate suction (except for tips where no coolant is used).
- > In case of coolant supply failure, the medical device must be stopped immediately (maximum operating time without coolant is 30 seconds). The exception are applications where no coolant is used (e.g. endodontics). Maximum operating time without coolant is 2 minutes.
- > Check the medical device for damage and loose parts each time before using (e.g., tip, handpiece cap).
- > Do not operate the medical device if it is damaged.
- > Perform a test run each time before using.
- > Do not look directly into the optic outlet.
- > Run the rinse function for the dental unit once per day.
- > Replace damaged or leaking O-rings immediately.
- > Do not twist, kink or squeeze the supply hose (risk of damage).



## Tips

- > Only use tips that have been approved by W&H and the associated tip changers or spanners.
- > An overview of the correct power settings is included with every tip.
- > With periodontal tips, the medical device is suitable for the removal of concretions in the subgingival region, but not for applications which demand sterile conditions. Choose the lower performance range when carrying out periodontal treatments on hypersensitive patients in order to guarantee optimum pain-free treatment.
- > Ensure that the original shape of the tips is not affected (e.g. by being dropped).
- > The tips must not be bent back into shape or resharpened.
- > Locate and secure the tip only with the medical device switched off.
- > Never touch the tips when vibrating.
- > Insert the tip changer onto the inserted tip of the stationary medical device after every treatment (protection against injury and infection, tip protection). Tips that are changed using a spanner must be removed from the medical device immediately after treatment.
- > Do not touch into the tip changer (with tip inserted).
- > Check for the effect of wear on the tips using the accompanying tip card.
- > Change tips if there are visible signs of wear.



### **Approved coolants and rinsing liquids**

- > Physiological saline solution (NaCl, 0.9%)
- > Hydrogen peroxide ( $H_2O_2$ , 1–3%)
- > Liquids with the active substance chlorhexidine (CHX, 0.2%)
- > Tap water





The medical device is tailored to the W&H supply hose and the W&H control electronics and must therefore only be used with W&H products. Using other components could lead to deviating parameters or even the destruction of the system.



**Risks due to electromagnetic fields**

This medical device complies with the reference values defined in EN 50527-2-1/2016 for active implantable medical devices (AIMD) and cardiac pacemakers.



The medical device is not approved for operation in potentially explosive atmospheres.

## Hygiene and maintenance prior to initial use



- > The medical device is not sterilized when delivered.
- > The packaging is non-sterilizable.
  
- > Clean and disinfect the medical device, the tips and the tip changer.
- > Sterilize the medical device, the tips and the tip changer.

### 3. Product description

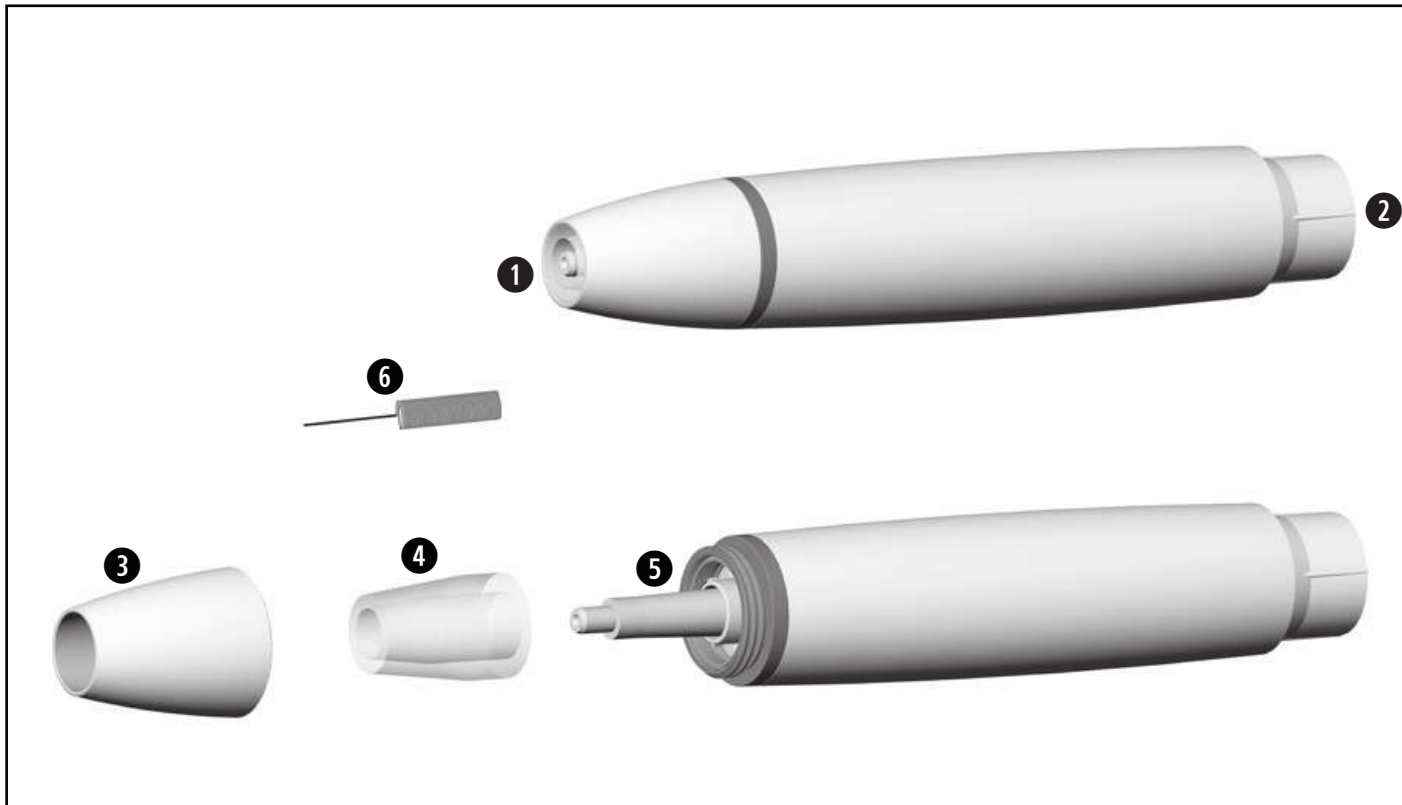

- ① Thread
- ② Connection for supply hose
- ③ Handpiece cap
- ④ Optical fibre
- ⑤ Optic outlet
- ⑥ Nozzle cleaner

## 4. Operation

## Assembly/Removal

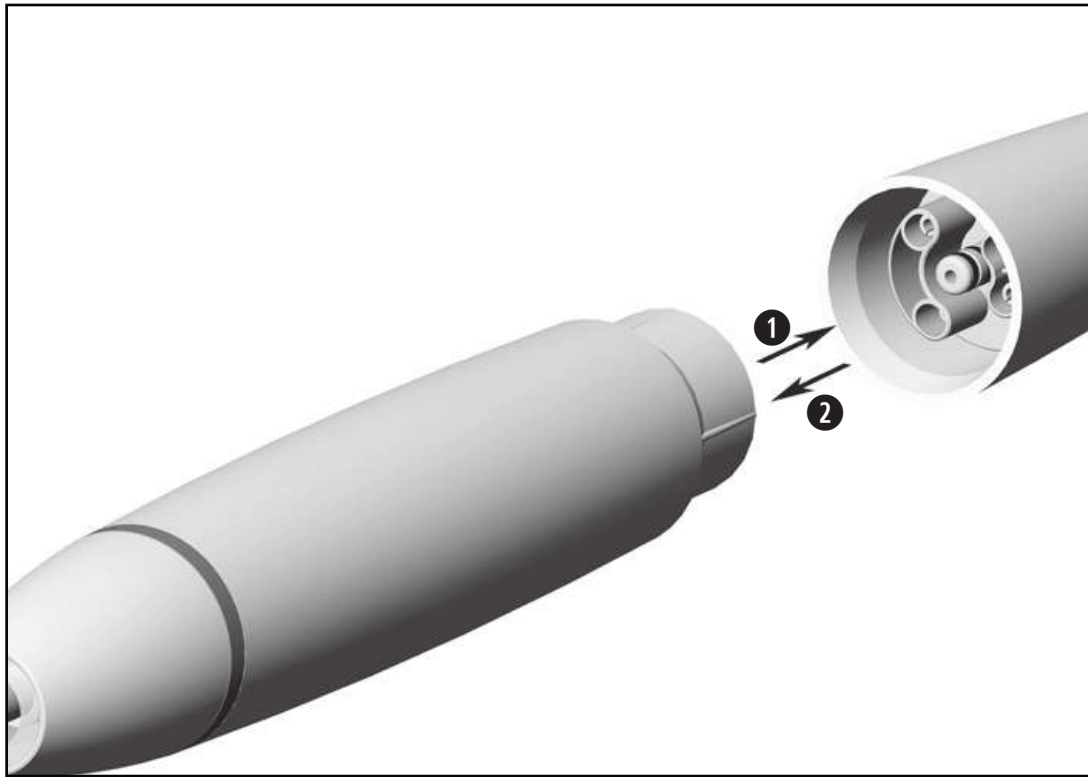

❶ Push the medical device onto the supply hose.

 Note the positioning.

❷ Remove the medical device.

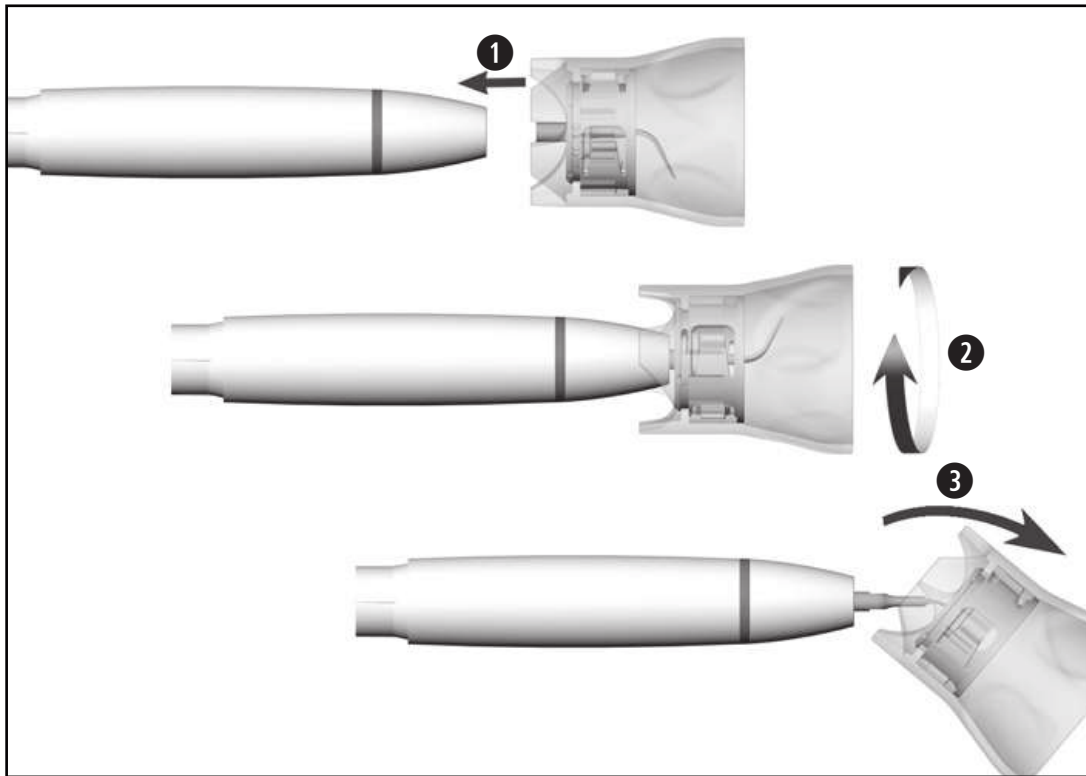

## Insert tip with tip changer



Ensure the matching thread system  
(at the handpiece, tip changer, tip)!

- 1 Position the tip on the thread of the medical device.
- 2 Turn the tip changer until it audibly engages.
- 3 Withdraw the tip changer.



Verify full engagement.



Press the tip with about 1 N (= 100 g) pressure onto a firm object to test the loading capacity of the tip.

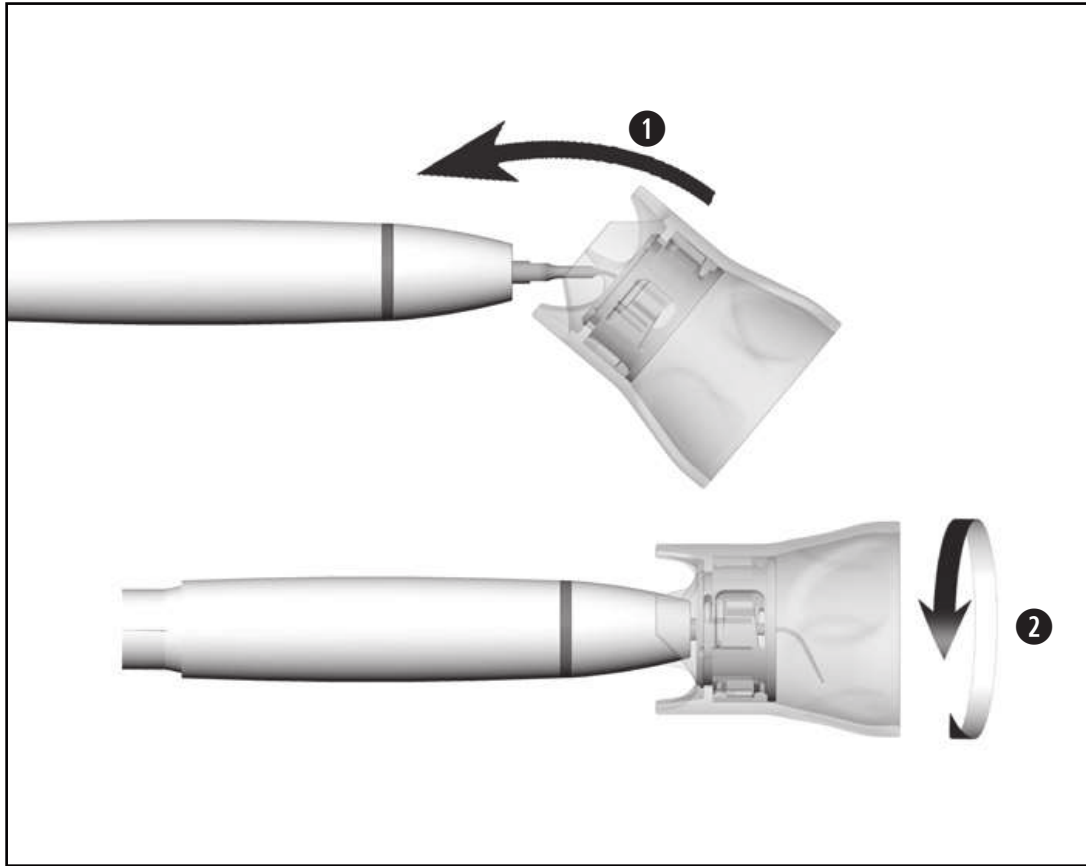

## Remove tip with tip changer

- 1 Place the tip changer onto the tip.
- 2 Unscrew the tip with the tip changer.



Leave the tip in the tip changer until the hygienic maintenance process!

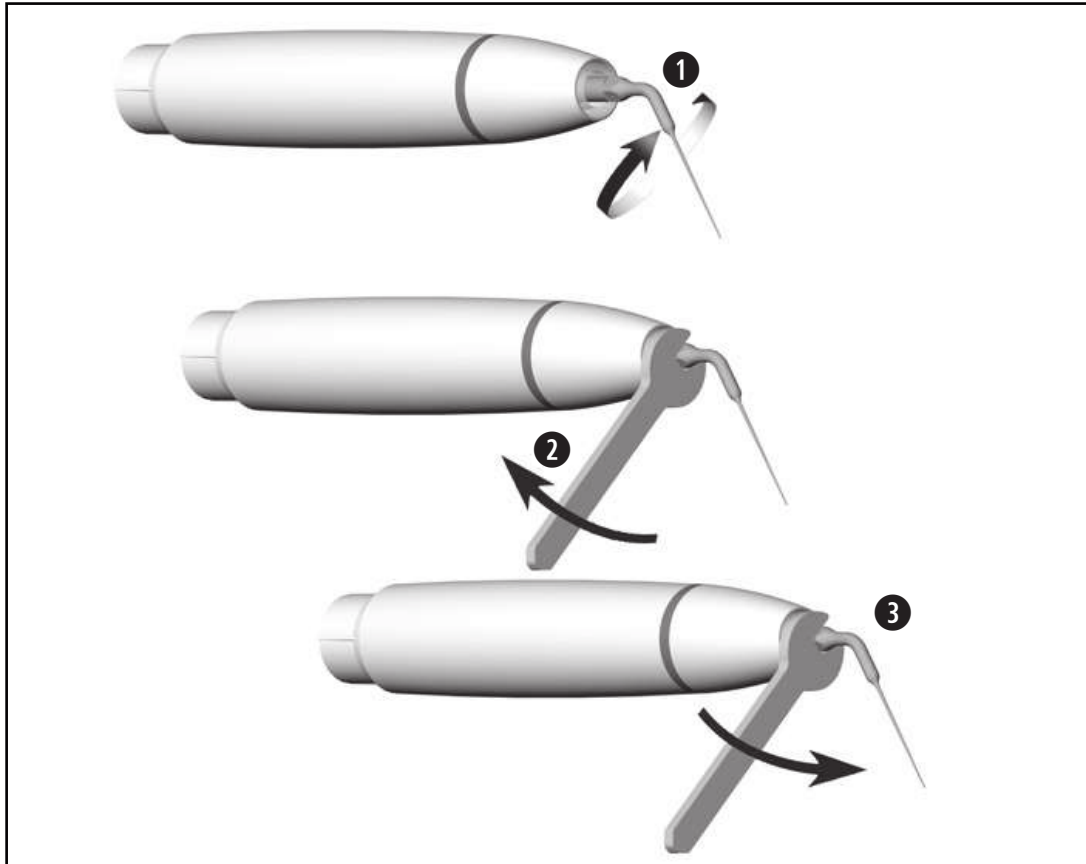

### Insert/remove tip with spanner

- ① Position the tip on the thread of the medical device.
- ② Screw the tip down.



Verify full engagement.

- ③ Unscrew the tip.

## Test run



Do not hold the medical device at eye level!

- > Attach the medical device to the supply hose.
- > Insert the tip.
- > Put the medical device into operation.



In the event of operating malfunctions (e.g. vibrations, unusual noise, overheating, coolant supply failure or leakage) **stop the medical device immediately** and contact an authorized W&H service partner.



## 5. Hygiene and maintenance

## General notes

 Follow your local and national laws, directives, standards and guidelines for cleaning, disinfection and sterilization.

 > Wear protective clothing, safety glasses, face mask and gloves.

 > Use only oil-free, filtered compressed air with a maximum operating pressure of 3 bar for manual drying.

## Cleaning agents and disinfectants



- > Read the notes, follow the instructions and heed the warnings provided by the manufacturers of cleaning agents and/or disinfectants.
- > Use only detergents which are intended for cleaning and/or disinfecting medical devices made of metal and plastic.
- > It is imperative to comply with the concentrations and exposure times specified by the manufacturer of the disinfectant.
- > Use disinfectants which have been tested and found effective by the Verbund für Angewandte Hygiene e.V. (VAH = Association for Applied Hygiene), the Österreichischen Gesellschaft für Hygiene, Mikrobiologie und Präventivmedizin (ÖGHMP = Austrian Society for Hygiene, Microbiology and Preventive Medicine), the Food and Drug Administration (FDA) and the U.S. Environmental Protection Agency (EPA).



The user is responsible for validating its process if the specified cleaning agents and disinfectants are not available.

 The product lifetime and the medical device's ability to operate correctly are mainly determined by mechanical stress during use and chemical influences due to processing.

- > Send worn or damaged medical devices and/or medical devices with material changes to an authorized W&H service partner.

### Processing cycles

-  > We recommend a regular service for the W&H medical device after 500 processing cycles or one year.
- > We recommend to replace the tip changer after 250 processing cycles.
  - > Check signs of wear on the tips (see tip card).



Clean the medical device immediately after every treatment, to flush out liquid (e.g., blood, saliva etc.) and to prevent settling on the internal parts.

- > Operate the medical device for at least 10 seconds at idle speed.
- > Ensure that all coolant outlets are rinsed out.



- > Wipe the entire surface of the medical device, the tip and the tip changer with disinfectant.
- > Remove the tip.
- > Remove the medical device.



Note that the disinfectant used during pre-treatment is only for personal protection and cannot replace the disinfectant step after cleaning.

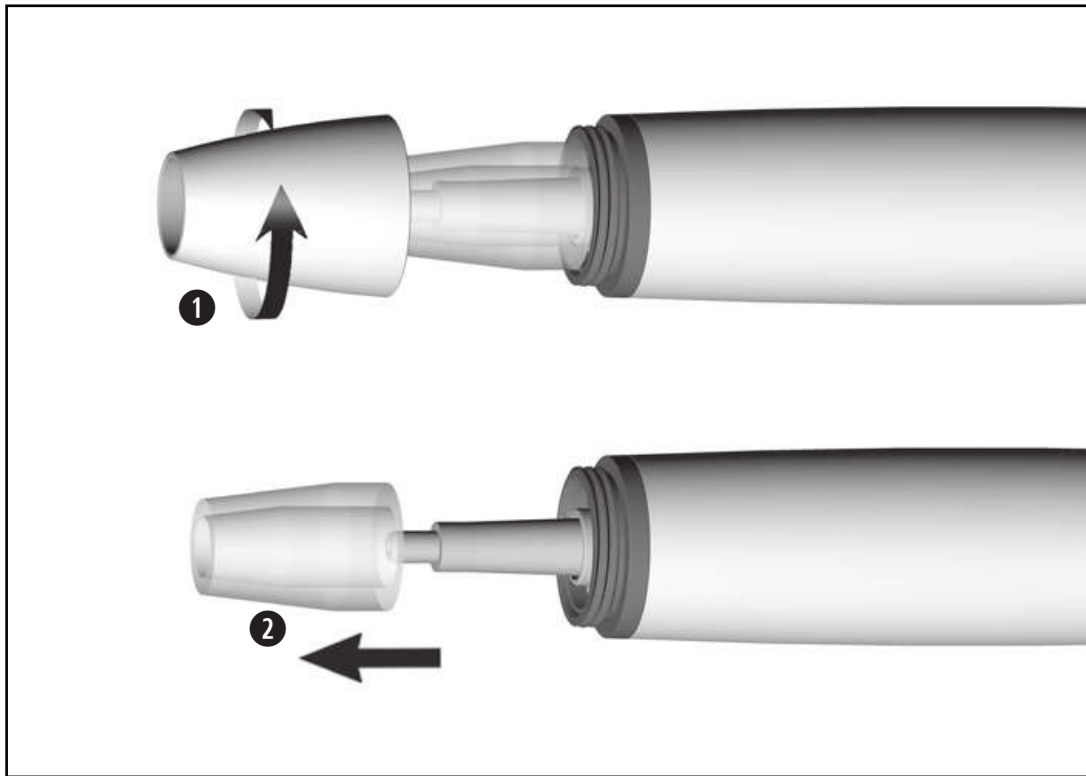

### Disassembling the medical device

- 1 Unscrew the handpiece cap.
- 2 Remove the optical fibre.

 Do not place the medical device and the tip changer in liquid disinfectant or in an ultrasonic bath.

 Clean and disinfect diamond coated tips in an ultrasonic bath.

 Evidence of the tips basic suitability for effective manual cleaning and disinfection was provided by an independent test laboratory using the »Bandelin Type RK 100 CC« ultrasonic bath and the cleaning agent and disinfectant »StammopurDR8 (DR H Stamm, Berlin)«.

- > Clean the medical device under running tap water (< 35°C/< 95°F).
- > Rinse and brush off all internal and external surfaces.
- > Remove liquid residues using compressed air.

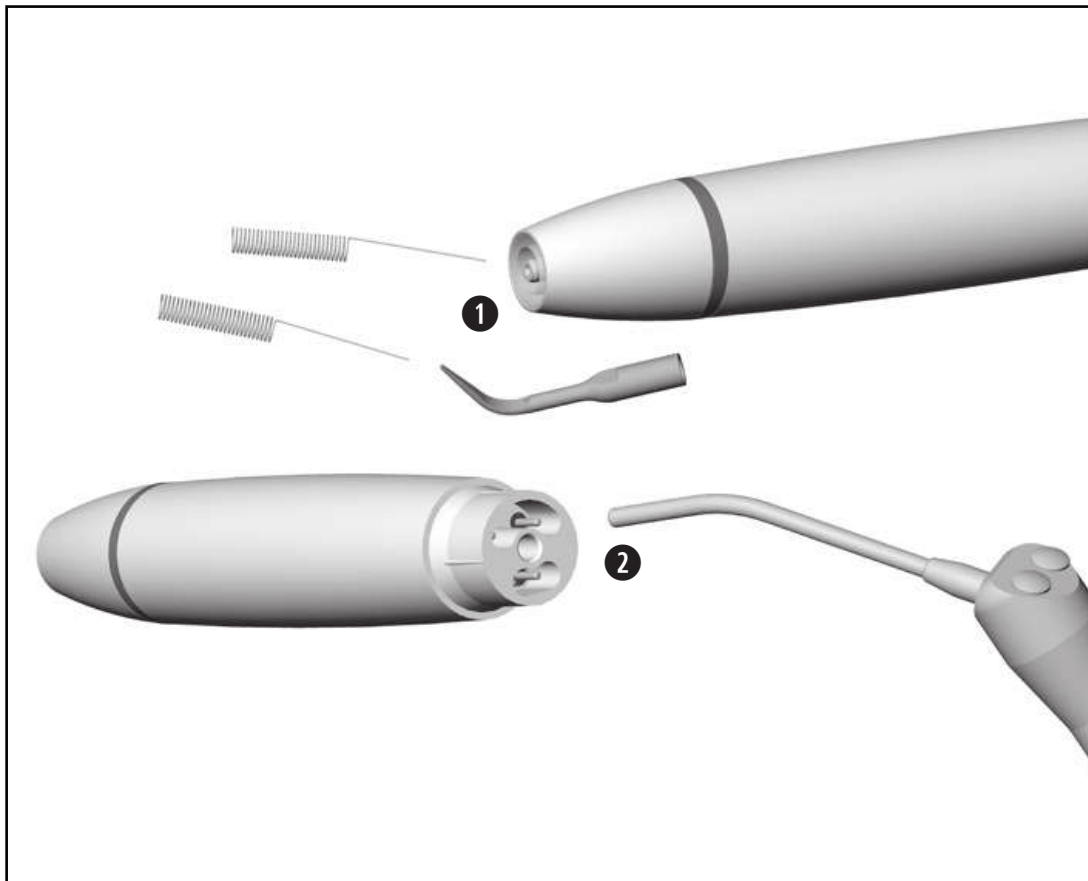

### **Cleaning the spray nozzles**

- ① Clean coolant outlets carefully with the nozzle cleaner to remove dirt and deposits.

 The nozzle cleaner can be cleaned in an ultrasonic bath and/or in the washerdisinfector.

### **Cleaning the coolant tube**

- ② Blow through the coolant tube using compressed air.

 In the case of clogged up coolant outlets or coolant tubes contact an authorized W&H service partner.

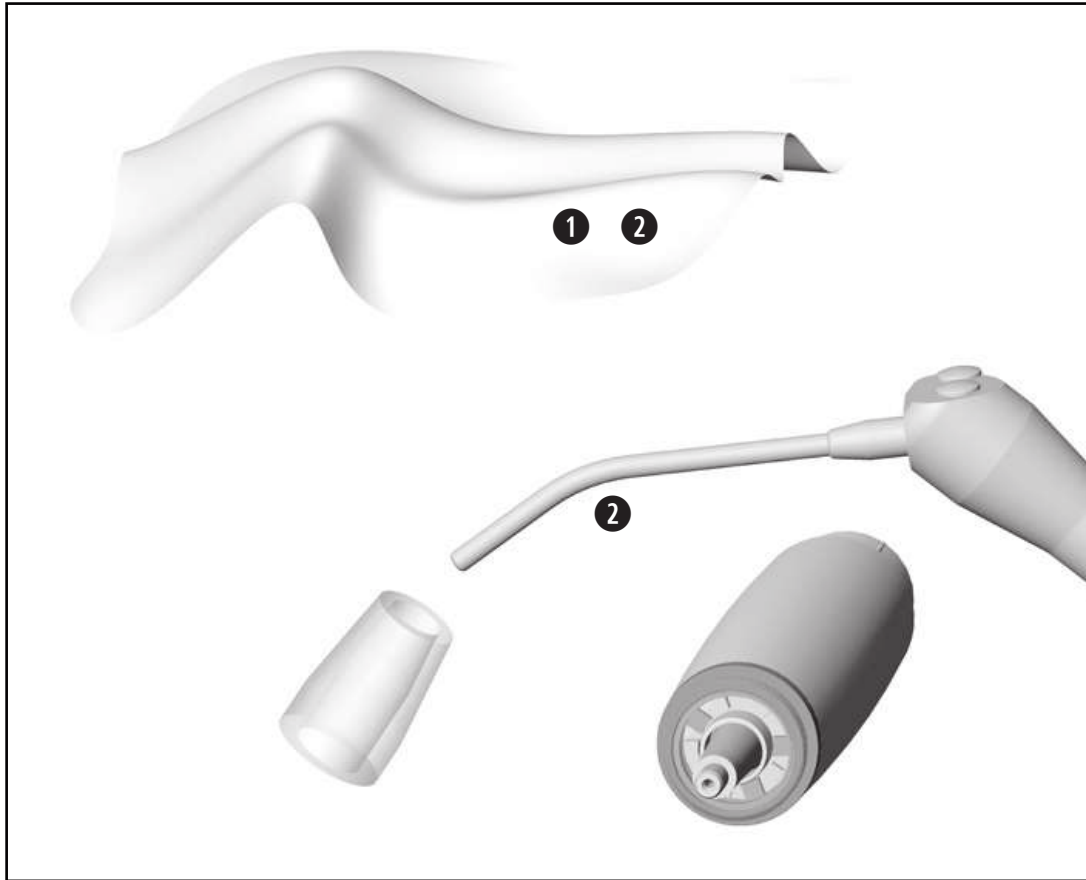

## Cleaning the optic outlet and the optical fibre



Avoid scratching the optic outlet and the optical fibre!

- ① Wash the optic outlet and the optical fibre with cleaning fluid and a soft cloth.
- ② Blow the optic outlet and the optical fibre dry using compressed air or dry it carefully with a soft cloth.



- > Carry out a visual inspection after each cleaning process.
- > Do not use the medical device if the optic outlet or the optical fibre is damaged and contact an authorized W&H service partner.





> W&H recommends wiping down with disinfectant.



Evidence of the medical device's, the tips' and the tip changer's basic suitability for effective manual disinfection was provided by an independent test laboratory using the »mikrozid<sup>®</sup> AF wipes« disinfectant (Schülke & Mayr GmbH, Norderstedt).



W&H recommends automated cleaning and disinfection using a washer-disinfector (WD).

- > Read the notes, follow the instructions and heed the warnings provided by the manufacturers of washer-disinfectors, cleaning agents and/or disinfectants.



Evidence of the basic suitability of the medical device, the tip and the tip changer for effective automated disinfection was provided by an independent test laboratory using the »Miele PG 8582 CD« washer-disinfector (Miele & Cie. KG, Gütersloh) and the »Dr. Weigert neodisher® MediClean forte« cleaning agent (Dr. Weigert GmbH & Co. KG, Hamburg) according to ISO 15883.

- > Cleaning at 55°C (131°F) – 5 minutes
- > Disinfection at 93°C (200°F) – 5 minutes

### Mechanical cleaning and disinfection of the tips



Use the Miele A 814 adapter.



- > Ensure that the medical device, the tip and the tip changer are completely dry internally and externally after cleaning and disinfection.
- > Remove liquid residues using compressed air.

### Inspection



- > Check the medical device, the tip and the tip changer after cleaning and disinfection for damage, visible residual soiling and surface changes.
- > Reprocess any medical devices, the tip and the tip changer that are still soiled.

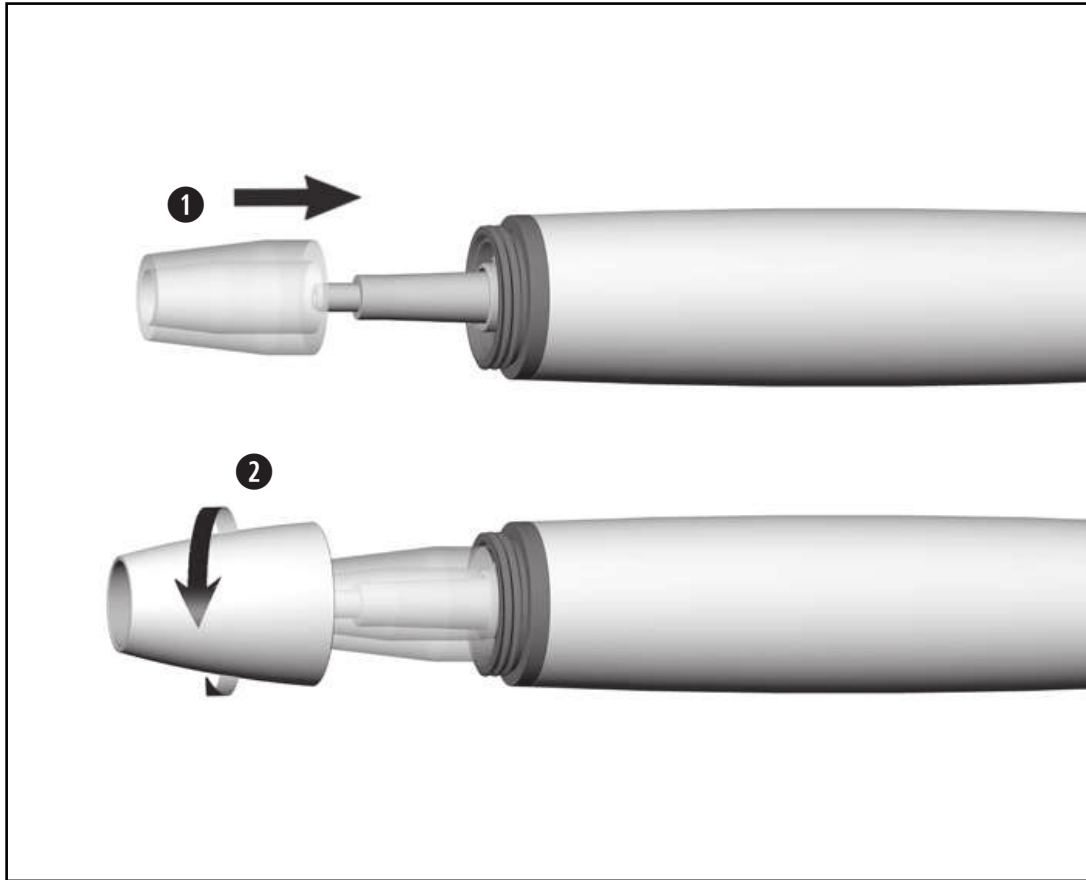

## Reassembling the medical device

 Reassemble the medical device following cleaning and disinfection.

- 1 Fit optic fibre onto medical device.
- 2 Screw on the handpiece cap.

 Sterilize the medical device, the tip and the tip changer following cleaning and disinfection.



Pack the medical device, the tip and the tip changer in sterilization packages that meet the following requirements:

- > The sterilization package must meet the applicable standards in respect of quality and use and must be suitable for the sterilization method.
- > The sterilization package must be large enough for the sterilization goods.
- > The filled sterilization package must not be under tension.



W&H recommends sterilization according to EN 13060, EN 285 or ANSI/AAMI ST79.



- > Read the notes, follow the instructions and heed the warnings provided by the manufacturers of steam sterilizers.
- > The program selected must be suitable for the medical device.



- > Only sterilize the tip in the tip changer. This does not include tips which are replaced using the spanner.

## Recommended sterilization cycles

- > Steam sterilization (type B, S, N)
- > Sterilization time at least 3 minutes at 134°C (273°F), 4 minutes at 132°C (270°F), 30 minutes at 121°C (250°F)
- > Maximum sterilization temperature 135°C (275°F)



Evidence of the basic suitability of the medical device, the tip and the tip changer for effective sterilization was provided by an independent test laboratory using the LISA 517 B17L steam sterilizer (W&H Sterilization S.r.l., Brusaporto (BG)), the Systec VE-150 steam sterilizer (Systec) and the CertoClav MultiControl MC2-S09S273 steam sterilizer (CertoClav GmbH, Traun).

“Dynamic-air-removal prevacuum cycle” (type B): temperature 134°C (273°F) – 3 minutes\*  
temperature 132°C (270°F) – 4 minutes\*/\*\*

“Steam-flush pressure-pulse cycle” (type S): temperature 134°C (273°F) – 3 minutes\*

“Gravity-displacement cycle” (type N): temperature 121°C (250°F) – 30 minutes\*\*

\* EN 13060, EN 285, ISO 17665

\*\* ANSI/AAMI ST55, ANSI/AAMI ST79



### **Before starting operation again**



- > Wait until the medical device is completely dry.
- > Moisture in the medical device can lead to a malfunction! (Risk of short circuit)
- > Wait until the tip, the tip changer and the spanner have completely cooled down. (Risk of burning)



- > Store sterile goods dust-free and dry.
- > The shelf life of the sterile goods depends on the storage conditions and type of packaging.

## 6. Exchanging the supply hose O-rings



- ❶ Remove O-rings.
- ❷ Slide on the new O-rings with a pair of tweezers.

 Always change all O-rings to ensure tightness.

## 7. Servicing

---

### Repairs and returns

In the event of operating malfunctions immediately contact an authorized W&H service partner. Repairs and maintenance work must only be undertaken by an authorized W&H service partner.



> Ensure that the medical device has been completely processed before returning it.

## 8. W&H Accessories and spare parts

---



Use only original W&H accessories and spare parts or accessories approved by W&H.  
Suppliers: W&H partners

08025210 Handpiece cap and 3 optical fibres

00636901 Nozzle cleaner

02060203 O-ring for hose coupling (1 pc)

## 9. Technical data

		PB-5 L, PB-5 L S, PB-5 L Q
Max. power output to the handpiece with load (ultrasonic)	[W]	10
Frequency (ultrasonic)	[kHz]	22–35
Minimum coolant supply volume	[ml/min]	0*/20
Maximum coolant supply volume	[ml/min]	50
Water pressure	[bar]	1–6
Max. oscillating amplitude (Tip 1U)	[mm]	0.2

\* for tips where no coolant is used

**Classification according to § 6 of the General Specifications for the Safety of Medical Electrical Equipment according to IEC 60601-1/ANSI/AAMI ES 60601-1**



Type B applied part (not suitable for intracardiac application)

## **Temperature information**

Temperature of the medical device at the operator side:

maximum 71°C (159.8°F)

Temperature of the medical device at the patient side  
(front area of the medical device):

maximum 50°C (122°F)

Temperature of the medical device at the patient side  
(optical fibre):

maximum 48°C (118.4°F)

Temperature of the working part (tip):

maximum 41°C (105.8°F)

## **Ambient conditions**

Temperature during storage and transport:

-40°C to +70°C (-40°F to +158°F)

Humidity during storage and transport:

8% to 80% (relative), non-condensing

Temperature during operation:

+10°C to +35°C (+50°F to +95°F)

Humidity during operation:

15% to 80% (relative), non-condensing

Pollution level:

2

Overvoltage category:

II

Altitude:

up to 3,000 m above sea level

## 10. Disposal

---



Ensure that the parts are not contaminated on disposal.

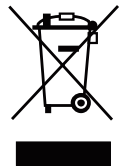

Follow your local and national laws, directives, standards and guidelines for disposal.

- > Medical device
- > Waste electrical equipment
- > Packaging



# Explanation of warranty terms

This W&H medical device has been manufactured with great care by highly qualified specialists. A wide variety of tests and controls guarantees faultless operation. Please note that claims under warranty can only be validated when all the directions in the Instructions for use have been followed.

**As the manufacturer, W&H is liable for material or manufacturing defects within a warranty period of 24 months from the date of purchase. Accessories and consumables (tips, tip changer, nozzle cleaner) are excluded from the warranty.**

We accept no responsibility for damage caused by incorrect handling or by repairs carried out by third parties not authorized to do so by W&H!

Claims under warranty accompanied by proof of purchase must be sent to the vendor or to an authorized W&H service partner. The provision of service under warranty extends neither the warranty period nor any other guarantee period.

# 24 months warranty



## Authorized W&H service partners

---

Find your nearest authorized W&H service partner at <http://wh.com>  
Simply go to the menu option »Service« for full details.

Or simply scan the QR code.



**Manufacturer**

**W&H Dentalwerk Bürmoos GmbH**

**Ignaz-Glaser-Straße 53, 5111 Bürmoos, Austria**

**t +43 6274 6236-0,      f +43 6274 6236-55**  
**office@wh.com      wh.com**

**Form-Nr. 51005 AEN**  
**Rev. 002 / 03.02.2020**  
**Subject to alterations**

## Instructions for Use



CE  
0297

**Foot control**  
**S-NW, S-N2, S-N1**

# Contents

---

Symbols.....	3
1. Introduction .....	8
2. Electromagnetic compatibility (EMC) .....	10
3. Scope of delivery.....	11
4. Safety notes .....	12
5. Attaching - detaching the locator.....	15
6. Foot control S-NW .....	16
Inserting and replacing batteries .....	16
Replacing the O-ring.....	17
Connecting and disconnecting the CAN dongle .....	18
Description of CAN dongle .....	19
Connecting and disconnecting the SPI dongle.....	20
Description of SPI dongle.....	21
Assistance with pairing problems .....	22
7. Foot control S-N2 / S-N1 .....	23
8. Hygiene and maintenance.....	24
9. Servicing .....	25
10. W&H accessories and spare parts.....	26
11. Technical data .....	27
12. Disposal .....	29
Explanation of warranty terms .....	30
Authorized W&H service partners.....	31
Manufacturer's declaration.....	32

# Symbols

# in the Instructions for Use



**WARNING!**  
(if persons could be injured)



**ATTENTION!**  
(if property could be damaged)















General explanations,  
without risk to persons or property



Foot control

# Symbols

## on the foot control S-NW

	CE marking with identification number of the Notified Body		Non-ionizing electromagnetic radiation		Catalogue number
	Do not dispose of with domestic waste		Battery compartment closed		Serial number
	DataMatrix code for product information including UDI (Unique Device Identification)		Battery compartment open		Date of manufacture
	Manufacturer		Category AP equipment		Medical Device
	UL Component Recognition Mark indicates compliance with Canadian and U.S. requirements				



# Symbols

# radio symbols on the foot control S-NW



GITEKI (MIC) – Japan



NCC – Taiwan

S-NW: CCAH19LP2780T2  
CAN dongle: CCAH19LP2790T5  
SPI dongle: CCAH19LP2800T8



ANATEL – Brazil

01237-16-03402



RCM – Australian / New Zealand

Contains FCC ID: QOQBLE113  
Contains IC: 5123A-BGTBLE113

FCC / IC – USA / Canada



IC – South Korea

KCC-CRM-BGT-BLE113

Complies with  
IMDA Standards  
DA103787

IMDA – Singapur\*

\*Symbol only in IFU

This device complies with part 15 of the FCC Rules. Operation is subject to the following two conditions: (1) this device may not cause harmful interference, and (2) this device must accept any interference received, including interference that may cause undesired operation.

This equipment has been tested and found to comply with the limits for a Class B digital device, pursuant to part 15 of the FCC Rules. These limits are designed to provide reasonable protection against harmful interference in a residential installation. This equipment generates, uses and can radiate radio frequency energy and, if not installed and used in accordance with the instructions, may cause harmful interference to radio communications. However, there is no guarantee that interference will not occur in a particular installation. If this equipment does cause harmful interference to radio or television reception, which can be determined by turning the equipment off and on, the user is encouraged to try to correct the interference by one or more of the following measures:

- > Reorient or relocate the receiving antenna.
- > Increase the separation between the equipment and receiver.
- > Connect the equipment into an outlet on a circuit different from that to which the receiver is connected.
- > Consult the dealer or an experienced radio/TV technician for help.

# Symbols

on the foot control S-N2 / S-N1



CE marking  
with identification number  
of the Notified Body



Catalogue number



Manufacturer



Do not dispose of with  
domestic waste



Serial number



Medical Device



DataMatrix code  
for product information  
including UDI (Unique Device  
Identification)



Date of manufacture



Category AP equipment



UL Component Recognition  
Mark indicates compliance  
with Canadian and U.S.  
requirements

# Symbols

## on the packaging

 CE marking  
with identification number  
of the Notified Body

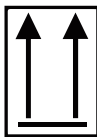
 This way up

 Fragile, handle with care

 Keep dry

 “Der Grüne Punkt” (The Green Dot)  
trademark of Duales System  
Deutschland GmbH

 Trademark of RESY OfW GmbH  
for identification of recyclable  
transport and outer packaging  
of paper and cardboard



DataMatrix code  
for product information including UDI  
(Unique Device Identification)



Data structure in accordance with  
Health Industry Bar Code

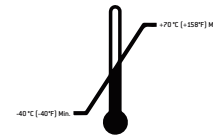

Temperature limitation



Humidity limitation

**R<sub>x</sub>**only

Caution! According to Federal law restricts this  
device to sale by or on the order of a physician,  
dentist, veterinarian or with the descriptive  
designation of any other practitioner licensed  
by the law of the State in which the practitioner  
practices to use or order the use of the device.

# 1. Introduction

---



## **For your safety and the safety of your patients**

These Instructions for use explain how to use your medical device. However, we must also warn against possible hazardous situations. Your safety, the safety of your team and, of course, the safety of your patients, are of paramount importance to us.



Observe the safety notes.

## **Intended use**

Foot control for operation of medical electrical equipment.



Misuse may damage the foot control and hence cause risks and hazards for patients, users and third parties.

## **Qualifications of the user**

We have based our development and design of the foot control for the physician, dental hygienists, dental employees (prophylaxis) and dental assistants target group.

# Introduction

---

Hereby, W&H declares that the medical product is in compliance with Directive 2014/53/EU (RED).  
The full text of the EU declaration of conformity is available at the following internet address <https://wh.com>

## Responsibility of the manufacturer

The manufacturer can only accept responsibility for the safety, reliability and performance of the foot control when it is used in compliance with the following directions:

- > The foot control must be used in accordance with these Instructions for Use and with the Instructions for Use of the drive unit.
- > The foot control has no components that can be repaired by the user.
- > Modifications or repairs must only be undertaken by an authorized W&H service partner (see page 31).
- > Unauthorized opening of the foot control invalidates all claims under warranty and any other claims.

The respective foot control may only be used with the control unit listed in the scope of delivery.

Improper use, unauthorized assembly, modification or repair to the medical device, non-compliance with our instructions or the use of accessories and spare parts which are not approved by W&H, invalidates all claims under warranty and any other claims.



Any serious incident that has occurred in relation to the medical device should be reported to the manufacturer and the competent authority!

## 2. Electromagnetic compatibility (EMC)

---



Medical electrical equipment is subject to particular precautions in regard to EMC and must be installed and put into operation in accordance with the EMC notes included.

W&H guarantees the compliance of the device with the EMC requirements only when used with original W&H accessories and spare parts. The use of accessories and spare parts not approved by W&H can lead to an increased emission of electromagnetic interference or to a reduced resistance against electromagnetic interference.

### **HF communication equipment**

Portable HF communications equipment (including peripherals such as antenna cables and external antennas) should be used no closer than 30 cm (12 inches) to the medical device. Otherwise, degradation of the performance of this medical device could result.

The medical device may be interfered by other equipment, even if these other devices comply with CISPR (International special committee on radio interference) emission requirements.

Use of this medical device adjacent to or stacked with other equipment should be avoided because it could result in improper operation. If such use is necessary, this medical device and the other equipment should be observed to verify that they are operating normally.

The medical device is not intended for use in the vicinity of HF surgical devices.

### 3. Scope of delivery

Foot control	Incl. dongle	Compatible with control unit*
S-NW, REF 30264000 S-NW, REF 30264003	REF 07759700	SI-1010/SI-1015/SI-1023, M-UK1010/ M-UK1015/M-UK1023, SA-430 M/SA-435 M Built-In Solution (to be agreed with the system assembler)
S-NW, REF 30264001	REF 07795800	SA-320, SA-310, SI-915/SI-923 (REF 16929000/16929001)
S-N2, REF 30285000 S-N2, REF 30285002		SI-1010/SI-1015/SI-1023, SI-915/SI-923 (REF 30286xxx, 30287xxx) M-UK1010/M-UK1015/M-UK1023, SA-430 M/SA-435 M Built-In Solution (to be agreed with the system assembler)
S-N1, REF 05046200		SI-915/SI-923 (REF 009001xx)
S-N1, REF 06202400		SA-310 SI-915/SI-923 (REF 16929000/16929001)
S-N1, REF 07004400		SA-320
S-N1, REF 06382200		PA-123, PA-115
Locator, REF 04653500		For all listed foot controls

Foot control S-NW
3 disposable batteries AA / Mignon / LR6 / 1.5V

\* Not included

## 4. Safety notes

## General



- > Before using the foot control for the first time, store it at room temperature for 24 hours.
- > Check the foot control for damage and loose parts each time before using.
- > Do not operate the foot control if it is damaged.
- > Replace the foot control as soon as the resistance is noticeably reduced.
- > Never touch the patient and the electrical contacts on the medical device simultaneously.
  
- > The ESD spring contact on the bottom of the foot control must be in contact with the ground during operation.



ESD is the abbreviation for “electrostatic discharge”.



The foot control is approved for use in explosive areas (AP).









### **Risks due to electromagnetic fields**

The functionality of implantable systems, such as cardiac pacemakers and implantable cardioverter defibrillator (ICD) can be affected by electric, magnetic and electromagnetic fields.

- > Find out if patient or user have implanted systems before using the medical device and consider the application.
- > Weigh the risks and benefits.
- > Keep the medical device away from implanted systems.
- > Make appropriate emergency precautions and take immediate action on any signs of ill-health.
- > Symptoms such as raised heartbeat, irregular pulse and dizziness can be signs of a problem with a cardiac pacemaker or ICD.

-  Keep the orange/middle button pressed and switch between the control units/applications.
-  **Disposable batteries**
  - > Replace the disposable batteries at the first prompt (battery icon on display or LED on dongle).
  - > Replace batteries outside explosive atmospheres only.
  - > Pay attention to the battery icon on the display before and after each treatment.
-  > Dispose faulty or flat batteries immediately and correctly via recycling systems. Do not dispose batteries in domestic waste.
-  > Use only high-quality disposable alkaline AA / Mignon / LR6 / 1.5 V batteries. Risk of explosion if the wrong type of battery is used.
  - > Do not mix new, old or different types of disposable batteries.
  - > Do not use rechargeable batteries.
  - > When inserting disposable batteries make sure that they are correctly oriented.
  - > Check the O-ring of the battery cover for damage. Replace a faulty or leaking O-ring immediately.
  - > Always keep spare batteries on hand.
-  Disposable batteries may cause damage due to leakage or corrosion.
  - > Remove the disposable batteries if you are not going to use the foot control for a longer period.
  - > See the safety notes of the battery manufacturer.

## 5. Attaching - detaching the locator

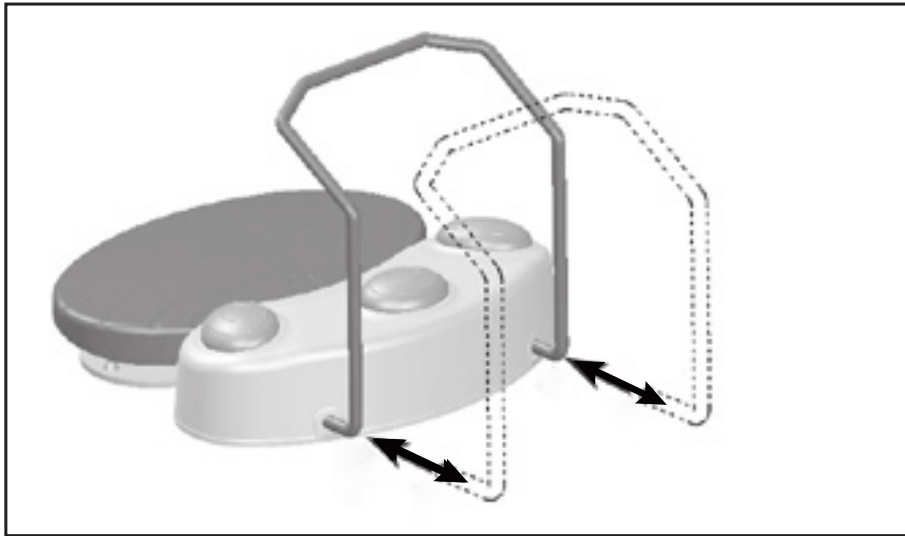

### Attaching and detaching the locator

- > Push it right in until the locator reaches the stop.
- > Pull the locator out.

## 6. Foot control S-NW

## Inserting and replacing batteries

### Open battery compartment



❶ Open the battery compartment.



Note the symbols!

### Remove batteries



❷ Pull the red thread to remove the batteries.

### Insert batteries



Reposition the red thread before inserting batteries.

❸ Insert the batteries.



Pay attention to the positioning!

### Lock battery compartment

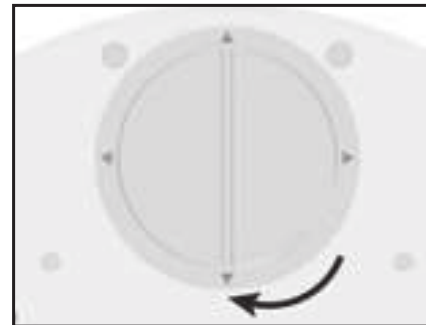

❹ Lock the battery compartment.

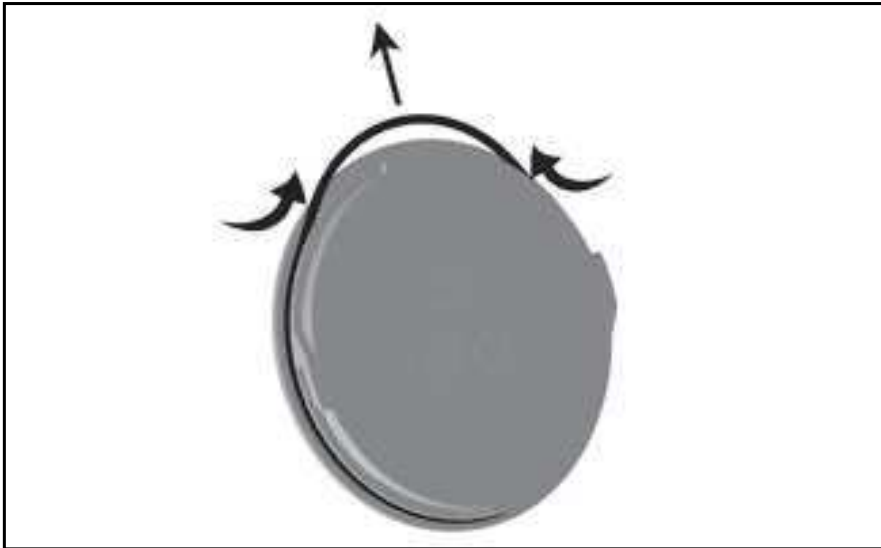

Do not use sharp tools!

- ① Firmly squeeze the O-ring between your thumb and index finger so that it forms a loop.
- ② Pull off the O-ring.
- ③ Push the new O-ring on in its place.

## Connecting CAN dongle



❶ Plug in the CAN dongle.

 Pay attention to the positioning!

## Removing CAN dongle



❷ Press the side lock and remove the CAN dongle.

### CAN dongle activated

-  Icon visible on display
- > CAN dongle inserted
  - > Control unit switched on
  - > Foot control actuated



### Pairing

- > The foot control S-NW and the CAN dongle are paired by default.
- > If pairing is inactive, you can activate pairing on the control unit (see Instructions for Use Implantmed/system assembler) and follow the directions.
- > Press and hold the green/left and orange/middle buttons simultaneously on the S-NW foot control for at least 3 seconds.

### Disable pairing

Press and hold all three buttons simultaneously on the foot control S-NW for at least three seconds.

### Switching between multiple control units

Press the orange/middle button for 3 seconds.

### Change application

Press the orange/middle button for 3 seconds until an acoustic signal sounds.

## Connecting and disconnecting the SPI dongle

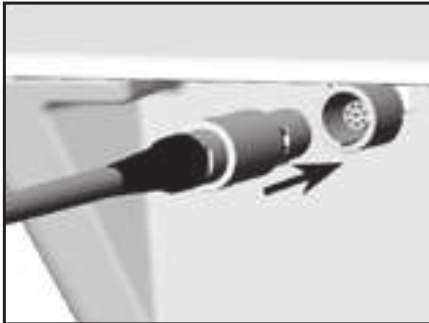

 Pay attention to the positioning!

❶ Plug in the SPI dongle or disconnect the SPI dongle from the control unit.



❷ Attach the SPI dongle to the irrigant support or remove the SPI dongle from the irrigant support.



### Green – SPI dongle activated

LED on if the SPI dongle is connected and the control unit is switched on.

### Orange – battery

LED flashes if the batteries on the foot control need to be replaced.

### Blue – pairing



The foot control S-NW and the SPI dongle are paired in default status.

If pairing is active: LED indicator flashes

If pairing is inactive:

- ① Press and hold the button on the SPI dongle for 4 seconds.
- ② LED indicator flashes. SPI dongle is in pairing mode for 30 seconds.
- ③ Press and hold the green and orange buttons simultaneously on the S-NW foot control.
- ④ LED flashes three times when pairing is successful.

### Disable pairing

Press and hold the green, orange and yellow buttons simultaneously on the foot control S-NW for at least three seconds.

### Switching between multiple control units

Press the orange/middle button for 3 seconds.

- > Check the plug-in connection of the dongle.
- > Remove metallic objects between foot control, control unit and dongle.
- > Change the position of the foot control.
- > Eliminate any sources of interference (e.g. brush motors, mobile telephones, radios, WLAN, ...).
- > Replace the pairing and repeat the pairing process.
- > Remove and replace the batteries.

If the pairing problem cannot be remedied using the steps described above, the unit will need to be inspected by an authorized W&H service partner.



 Pay attention to the positioning!

- ① Plug in the foot control S-N2 / S-N1 or disconnect the foot control from the control unit.

## 8. Hygiene and maintenance

---

### General notes



Follow your local and national laws, directives, standards and guidelines for cleaning.



> Wear protective clothing, safety glasses, face mask and gloves.



> The foot control is sealed and may be wiped clean.

> The foot control is not approved for automated processing in a washer-disinfector and sterilization.



> The ESD spring contact on the bottom of the foot control must be cleaned regularly.

## 9. Servicing

---



### **Regular checks**

Regular periodic inspection of the function and safety of the medical device is necessary and should be carried out at least once every three years, unless shorter intervals are prescribed by law.

The periodic inspection covers the complete medical device and must only be performed by an authorized service partner.

### **Repairs and returns**

In the event of operating malfunctions immediately contact an authorized W&H service partner.

Repairs and maintenance work must only be undertaken by an authorized W&H service partner.



- > Always return equipment in the original packaging
- > Foot control S-NW: Remove the batteries.

## 10. W&H accessories and spare parts



Use only original W&H accessories and spare parts or accessories approved by W&H.

Suppliers: W&H partners (Link: <https://www.wh.com>)



**07759700**

CAN dongle



**07795800**

SPI dongle



**04653500**

Locator for foot control

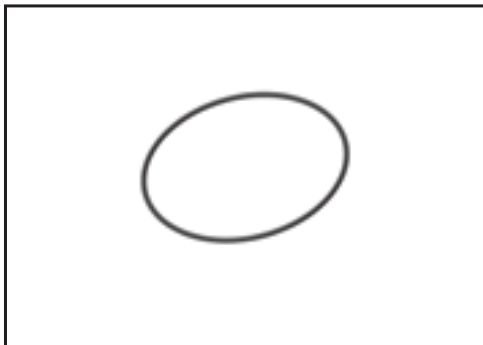

**07823400**

O-ring

## 11. Technical data

Foot control	S-NW	S-N2 / S-N1
Power supply:	3 disposable batteries AA / Mignon / LR6 / 1,5V	–
Dimensions in mm (height x width x depth):	154 x 202 x 210	156 x 207 x 206
Weight in kg:	1.2	1.3

Frequency band:	2.4 GHz ISM band (2.402 – 2.480 GHz)
Transmitting power:	Class 3:1 mW (0 dBm)
Modulation:	GFSK
Channels:	40 channels with 2 MHz spacing

Ambient conditions	
Temperature during storage and transport:	-40 °C to +70 °C (-40°F to +158°F)
Humidity during storage and transport:	8 % to 80 % (relative), non-condensing
Temperature during operation:	+10 °C to +40 °C (+50°F to +104°F)
Humidity during operation:	15 % to 80 % (relative), non-condensing

# Technical data

---

**Classification according to Paragraph 6 of the General Specifications for the Safety of Medical Electrical Device according to IEC 60601-1/ANSI/AAMI ES 60601-1**



S-NW / S-N2 / S-N1 are approved for operation in potentially explosive atmospheres.



S-NW / S-N2 / S-N1 are waterproof according to IPX8, 1 m depth of immersion, 1 hour (water-tight in accordance with IEC 60529)

Pollution level:

2

Altitude:

up to 3,000 m above sea level



## 12. Disposal

---



Ensure that the parts are not contaminated on disposal.



Follow your local and national, directives, standards and guidelines for disposal.

> Medical device



> Waste electrical equipment

> Packaging

# Explanation of warranty terms

This W&H product has been manufactured with great care by highly qualified specialists. A wide variety of tests and controls guarantees faultless operation. Please note that claims under warranty can only be validated when all the directions in the Instructions for Use have been followed.

**As the manufacturer, W&H is liable for material or manufacturing defects within a warranty period of twenty-four months from the date of purchase. Accessories and consumables (batteries, O-ring, locator for foot control) are not covered by the warranty.**

We accept no responsibility for damage caused by incorrect handling or by repairs carried out by third parties not authorized to do so by W&H!

Claims under warranty – accompanied by proof of purchase – must be sent to the vendor or to an authorized W&H service partner. The provision of service under warranty extends neither the warranty period nor any other guarantee period.

**24 months warranty**

## Authorized W&H service partners

---

Find your nearest authorized W&H service partner at <http://wh.com>  
Simply go to the menu option “Service” for full details.

Or simply scan the QR code.



# Manufacturer's declaration

## Manufacturer's declaration

### Electromagnetic compatibility (EMC)

WARNING: The use of cables, power supplies, accessories other than those specified by the manufacturer may result in increased emission and/or decreased immunity. Only use original V&H accessories.

cables and accessories	length	reference
foot controller S-N2	2.85 m	Manufacturer V&H REF 3028500x
foot controller S-N1	2.85 m	Manufacturer V&H REF 05203300
foot controller S-N1	2.85 m	Manufacturer V&H REF 05046200
foot controller S-N1	2.85 m	Manufacturer V&H REF 06202400
foot controller S-N1	2.85 m	Manufacturer V&H REF 06302200
foot controller S-N1	2.85 m	Manufacturer V&H REF 07004400
foot controller S-N1	—	Manufacturer V&H REF 30285400x
foot controller S-MV	0.5 m	Manufacturer V&H REF 07792800
SPI Dongle	—	Manufacturer V&H REF 07792800
CAN Dongle	—	Manufacturer V&H REF 07792800

Operate the product in a place with a maximum distance to electrical and magnetic interfering transmitters. If operation of the product close to other devices or together in a stack is necessary, observe the correct function of the system.

### Electromagnetic immunity (Table 2, IEC 60601-1-2:2007)

The product is suitable for use in a specific electromagnetic environment. The customer and/or the user of the product should assure that it is used in an electromagnetic environment as described below.

Immunity Test	IEC 60601-1 Level (3rd Ed.)	IEC 60601-1 Level (4th Ed.)	Compliance Level	Electromagnetic Environment Guidance
Electrostatic discharge (ESD) IEC 61000-4-2	± 8 kV contact ± 8 kV air	± 8 kV contact ± 15 kV air	± 8 kV contact ± 15 kV air	Floor should be wood, concrete or ceramic tile. If floors are covered with synthetic material, the relative humidity should be at least 30 %.
Electrical fast transients/bursts IEC 61000-4-4	± 2 kV for power supply lines ± 1 kV for input/output lines 100kHz repetition rate	± 2 kV for power supply lines ± 1 kV for input/output lines 100kHz repetition rate	± 2 kV for power supply lines ± 1 kV for input/output lines Both repetition rates	Mains power quality should be that of a typical commercial and/or hospital environment
Surge IEC 61000-4-5	± 1 kV line(s) to line(s) ± 2 kV line(s) to earth	± 1 kV line(s) to line(s) ± 2 kV line(s) to earth	± 1 kV line(s) to line(s) ± 2 kV line(s) to earth	Mains power quality should be that of a typical commercial and/or hospital environment
Voltage dips, short interruptions and voltage variations on power supply input lines IEC 61000-4-11	<5% U <sub>n</sub> (>85% dip in U <sub>n</sub> ) for 0.5 cycle  40% U <sub>n</sub> (60% dip in U <sub>n</sub> ) for 5 cycles  70% U <sub>n</sub> (30% dip in U <sub>n</sub> ) for 25 cycles  <4% U <sub>n</sub> (>95% dip in U <sub>n</sub> ) for 5 sec 3A/m	0% U <sub>n</sub> 0.5 cycle ⊕ 0° 45° 90° 135° 180° 0° 225° 270° & 315°  0% U <sub>n</sub> 1 cycle And 70% U <sub>n</sub> 2500° cycles ⊕ 0°  0% U <sub>n</sub> 250000° cycle	Complies to both editions requirements	Mains power quality should be that of a typical commercial and/or hospital environment. If the user of the product requires continued operation during power mains interruptions, it is recommended that the product be powered from an uninterruptible power supply or a battery.
Power frequency (50/60 Hz) magnetic field IEC 61000-4-8	3A/m	30A/m	30A/m	Power frequency magnetic fields should be at levels characteristic of a typical location in a typical commercial or hospital environment.

Note: U<sub>n</sub> is the mains (AC) voltage before apply test levels  
\* 25/30 (250/300) means cycles at 50/60Hz

# Manufacturer's declaration

**Electromagnetic Immunity II (Table 4, IEC 60601-1-2:2007)**  
 The product is suitable for use in a specific electromagnetic environment. The customer and/or the user of the product should assure that it is used in an electromagnetic environment as described below.

Immunity Test	IEC 60601-Level (3rd Ed.)	IEC 60601-Level (4th Ed.)	Compliance Level	Electromagnetic Environment Guidance
Conducted RF IEC 61000-4-6	3 V <sub>rms</sub> 150 kHz to 80 MHz	3 V <sub>rms</sub> 150 kHz to 80 MHz & V <sub>rms</sub> in ISM and amateur radio bands* between 0,15 MHz and 80 MHz	6 V <sub>rms</sub>	Portable and mobile RF communications equipment should be used no closer to any part of the product, including cables, than the recommended separation distance calculated from the equation applicable to the frequency of the transmitter.  Recommended separation distance: $d = 1,2 \sqrt{P}$
Radiated RF IEC 61000-4-3	3 V/m 80 MHz to 2,5 GHz	10 V/m 80 MHz to 2,7 GHz	10 V/m	$d = 1,2 \sqrt{P}$ for 80 MHz to 800 MHz  $d = 2,3 \sqrt{P}$ for 800 MHz to 2,5 GHz  where P is the maximum output power rating of the transmitter in Watt (W) according to the transmitter manufacturer and d is the recommended separation distance in meters (m)  Field strengths from fixed RF transmitters, as determined by an electromagnetic site survey <sup>b</sup> , should be less than the compliance level <sup>b</sup> in each frequency range   Interference may occur in the vicinity of equipment marked with the symbol described lateral.
<p><b>Note 1:</b> At 80 MHz and 800MHz, the higher frequency range applies.</p> <p><b>Note 2:</b> These guidelines may not apply in all situations. Electromagnetic propagation is affected by absorption and reflection from structures, objects, people and animals.</p> <p>* The ISM (industrial, scientific and medical) bands between 0,15 MHz and 80 MHz are 6,785 MHz to 6,795 MHz; 13,553 MHz to 13,567 MHz; 26,957 MHz to 27,283 MHz; and 40,68 MHz to 40,70 MHz. The amateur radio bands between 0,15 MHz and 80 MHz are 1,8 MHz to 2,0 MHz; 3,5 MHz to 4,0 MHz; 5,3 MHz to 5,4 MHz; 7 MHz to 7,2 MHz; 10,1 MHz to 10,15 MHz; 14 MHz to 14,2 MHz; 18,07 MHz to 18,17 MHz; 21,0 MHz to 21,4 MHz; 24,99 MHz to 24,99 MHz; 28,0 MHz to 29,7 MHz and 50,0 MHz to 54,0 MHz.</p> <p>* Field strengths from fixed transmitters, such as base stations for radio (cellular/cordless) telephones and land mobile radios, amateur radio, AM and FM radio broadcast and TV broadcast cannot be predicted theoretically with accuracy. To assess the electromagnetic environment due to fixed RF transmitters, an electromagnetic site survey should be considered. If the measured field strength in the location in which the product is used exceeds the applicable RF compliance level above, the product should be observed, additional measures may be necessary, such as reorienting or relocating the product.</p>				
<p><sup>b</sup> Over the frequency range 150 kHz to 80 MHz, field strengths should be less than 3 V/m.</p>				

# Manufacturer's declaration

Immunity level of RF fields from wireless communication devices  
(Table 9, IEC 60601-1-2:2014)

Test frequency (MHz)	Band <sup>1)</sup> (MHz)	Service <sup>2)</sup>	Modulation <sup>3)</sup>	Maximum power (W)	Distance (m)	IMMUNITY TEST LEVEL (V/m)
365	360-360	TETRA 400	Pulse modulation <sup>3)</sup> 18 Hz	1.8	0.3	27
450	430-470	GMRS 450, FRS 480	FM <sup>3)</sup> ± 5 kHz deviation 1 M <sup>2</sup> -2 sine	2	0.3	26
710	704-767	LTE Band 13, 17	Pulse modulation <sup>3)</sup> 217 Hz	0.2	0.3	9
810		GSM 800/900, TETRA 800, DEN 830, CDMA 850, LTE Band 5	Pulse modulation <sup>3)</sup> 18 Hz	2	0.3	26
870	800-960					
800						
1720		GSM 1800, CDMA 1900, GSM 1900, DECT, LTE Band 1, 3, 4, 25, UMTS	Pulse modulation <sup>3)</sup> 217 Hz	2	0.3	26
1845	1700-1960					
1970						
2450	2400-2570	Bluetooth, WLAN, 802.11 b/g/n, RFID 2450, LTE Band 7	Pulse modulation <sup>3)</sup> 217 Hz	2	0.3	26
5240						
5500	5100-5600	WLAN 802.11 a/n	Pulse modulation <sup>3)</sup> 217 Hz	0.2	0.3	9
5785						

NOTE: If necessary to achieve the IMMUNITY TEST LEVEL, the distance between the transmitting antenna and the product may be reduced to 1 m. The 1 m test distance is permitted by IEC 61000-4-3.

<sup>1)</sup> For some services, only the uplink frequencies are included.  
<sup>2)</sup> The carrier shall be modulated using a 50 % duty cycle square wave signal.  
<sup>3)</sup> As an alternative to FM modulation, 50 % pulse modulation at 10 Hz may be used because while it does not represent actual modulation, it would be worst case.

# Manufacturer's declaration

## Recommended Separation Distances between portable and mobile HF- communications equipment and the product (Table 6, IEC 60601-1-2:2007)

The product is intended for use in an electromagnetic environment in which radiated RF disturbances are controlled. The customer or the user of the product can help prevent electromagnetic interference by maintaining a minimum distance between portable and mobile RF communications equipment (transmitters) and the product – according on output power and frequency of the communications equipment – as recommended in the following table.

Rated maximum output power of transmitter in watts (W)	Separation distance according to the frequency of transmitter in meter (m)		
	150 kHz to 80 MHz	80 MHz to 800 MHz	800 MHz to 2.5 GHz
	$d = 1.2 \cdot P$	$d = 1.2 \cdot P$	$d = 2.3 \cdot P$
0.01	0.12	0.12	0.23
0.1	0.36	0.36	0.73
1	1.2	1.2	2.3
10	3.6	3.6	7.3
100	12	12	23

For transmitters rated at a maximum output power not listed above, the recommended separation distance  $d$  in meters, can be estimated using the equation applicable to the frequency of the transmitter, where  $P$  is the maximum output power rating of the transmitter in watts (W) according to the transmitter manufacturer.

Note 1: At 80 MHz and 800MHz, the higher frequency range applies.  
 Note 2: These guidelines may not apply in all situations. Electromagnetic propagation is affected by absorption and reflection from structures, objects, people and animals.

## Electromagnetic Emission (Table 1, IEC 60601-1-2:2007)

The product is suitable for use in a specific electromagnetic environment. The customer and/or the user of the product should assure that it is used in an electromagnetic environment as described below.

Emission Test	Compliance	Electromagnetic Environment Guidance
RF-emission CISPR 11	Group 1	The product use RF energy only for its internal function. Therefore, its RF emissions are very low and not likely to cause any interference in nearby electronic equipment. However, a separation distance of 30 cm shall be maintained.
RF-emission CISPR 11	Class B	The product is suitable for use in all establishments, including domestic establishments and those directly connected to the public low-voltage power supply network that supplies buildings used for domestic purpose.
Harmonic emissions IEC 61000-3-2 (*)	Class A	
Voltage fluctuations/ flicker emissions IEC 61000-3-3 (*)	complies	

(\*) Remark: for devices with power consumption of 75 W to 1000 W only

**Manufacturer**

**W&H Dentalwerk Bürmoos GmbH**  
**Ignaz-Glaser-Straße 53, 5111 Bürmoos, Austria**

**t + 43 6274 6236-0,      f + 43 6274 6236-55**  
**office@wh.com          wh.com**

**Form-Nr. 50882 AEN**  
**Rev. 006 / 04.06.2021**  
**Subject to alterations**





# Minilight



Installation and use manual



LUZZANI DENTAL S.R.L.

Via Torino, 3  
20030 Senago (MI)  
Italy

[www.luzzani.it](http://www.luzzani.it)

E-mail: [info@luzzani.it](mailto:info@luzzani.it)

Tel.: +39 029988433  
Fax: +39 0299010379

ED. 5 REV. 0



MADE IN ITALY



1 3 7 0

# CONTENTS

0 — SYRINGE LEGEND	8 — CLEANING AND STERILIZATION
1 — WARNINGS	9 — MAINTENANCE
2 — PRODUCT DESCRIPTION	10 — DISPOSAL AND SCRAPPING
2.1 — GENERAL	11 — INFORMATION FOR THE DENTIST
2.2 — GENERAL CHARACTERISTICS	12 — FAULT REPORT FORM
2.3 — MODELS	13 — SYMBOLS
2.4 — CONTROLS	14 — WIRING DIAGRAM
2.5 — CE MARKING	
3 — IDENTIFICATION DATA AND WARRANTY	
3.1 — MANUFACTURING BATCH	
3.2 — WARRANTY	
4 — PACKAGING	
5 — TECHNICAL CHARACTERISTICS	
5.1 — OPERATING CONDITIONS	
5.2 — TRANSPORT AND STORAGE CONDITIONS	
6 — INSTALLATION AND CONNECTIONS	
6.1 — CONNECTION TO ELECTRICAL SYSTEM	
6.2 — CONNECTION TO HYDRAULIC SYSTEM	
6.3 — CONNECTION TO COMPRESSED AIR SYSTEM	
6.4 — CONNECTION OF STRESS ABSORBER CORD	
6.5 — NOTES FOR CORRECT CONNECTION	
7 — NORMAL USE	
7.1 — INSUFFLATION OF COLD WATER	
7.2 — INSUFFLATION OF COLD AIR	
7.3 — COMBINED INSUFFLATION OF COLD WATER AND AIR (SPRAY)	
7.4 — INSUFFLATION OF WARM WATER (present in version 6f and L)	
7.5 — INSUFFLATION OF WARM AIR (present in version 6f and L)	
7.6 — COMBINED INSUFFLATION OF WARM WATER AND AIR (SPRAY) (present in version 6f and L)	
7.7 — LIGHT FUNCTION	
7.8 — FIRST TIME USE AND USE AFTER LONG PERIODS OF NON-USE	

0 — SYRINGE LEGEND

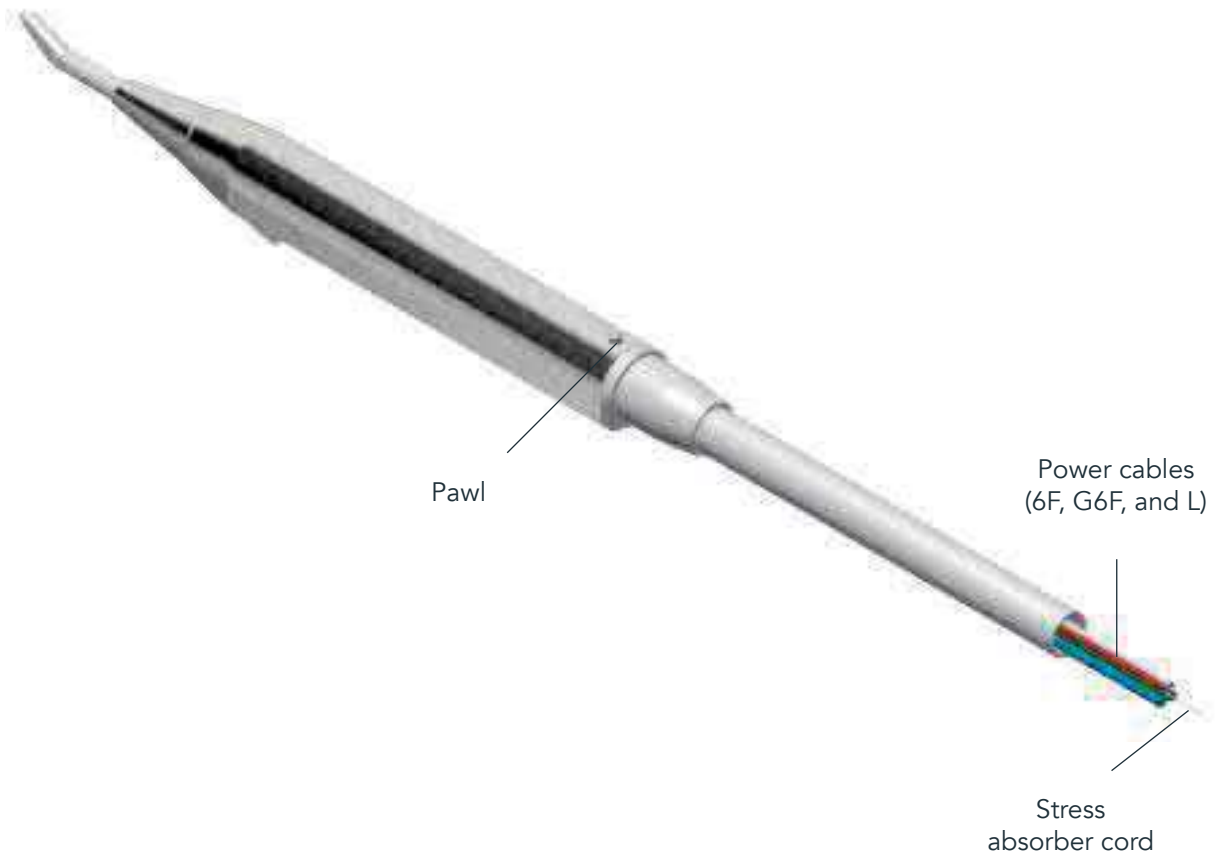
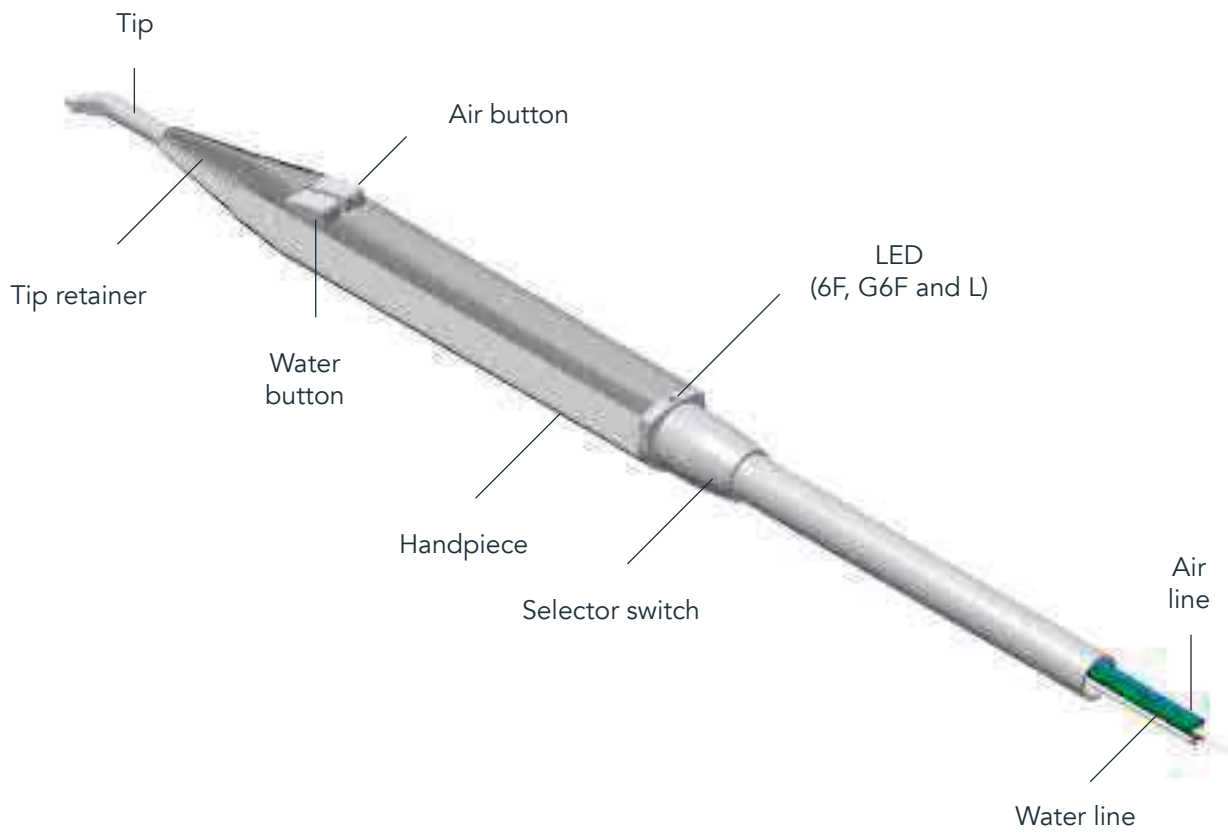

## 1 — WARNINGS

1.1 — Any unauthorised tampering, modification or improper use immediately terminates the warranty and exonerates our company from all liability for injury or damage to persons, animals or property that may be caused by such interference.

1.2 — To ensure maximum user and patient safety, the transformer used must be rated Safe Extra Low Voltage (SELV) with CE marking for medical use, in compliance with IEC 80.601 and IEC 60.601.

1.3 — Connection to terminals with output voltage exceeding 24 V could irreparably damage the device.

1.4 — The stress absorber cord must be anchored to the dental unit. This cord is designed to absorb any strains, thus preventing abnormal traction on the electrical or air/water line connections.

1.5 — Before use, the electric, water and air lines must be correctly connected. The syringe could be damaged if used when not connected to the water and air supplies. The lines must be connected correctly since inverting them would damage the syringe.

1.6 — To meet the requirements of Directive 93/42/EEC, the company has established a post-marketing surveillance procedure to monitor any problems generated by the use of our products. The attached form allows you to report any faults and suggest improvements which will be considered for subsequent versions of the product.

1.7 — With each syringe, the package also includes a User's manual which also includes a "Fault Report Form". Since this is required by law, the user must receive this User's manual. Therefore, the syringe installer is responsible for delivering this User's manual to the dentist. Directive 93/42/EEC requires product traceability: therefore, our customers are asked to ensure that, in case of emergency, we can identify the end customer to whom the product has been sold.

1.8 — Manufacturers and/or installers of dental units are required to comply with all the prescriptions outlined in this document.

1.9 — Use the Minilight syringe only for the applications described in the instructions for use.

1.10 — This product must only be installed by qualified persons.

1.11 — Never modify the syringe in any way. This is strictly forbidden.

1.12 — Use only original parts produced or approved by the manufacturer. If non-OEM accessories or consumables are used, the company cannot guarantee safe operation and function. No claims can be made for damages resulting from improper use.

1.13 — Disposable tip adapters are not part of the Minilight Syringe and may compromise proper functioning.

1.14 — Do not use the device in close contact with anaesthetic gases or in highly oxygenated environments (with an oxygen content >25%) or in areas where there is a risk of explosion.

1.15 — Do not perform any maintenance procedures not indicated in the manual.

1.16 — Before using the syringe, make certain that the water and air supplies have been activated.

1.17 — National regulations regarding dental unit water and air quality must be met.

1.18 — The air used must be dry, clean and free of oil.

1.19 — The Minilight syringe meets the requirements laid out in European Council Directive 93/42/EEC: Class II A

1.20 — The Minilight syringe must not be used near or set on other devices.

1.21 — Use only accessories, cables, transducers specified or supplied by Luzzani Dental.

1.22 — Do not use mobile RF communication devices within a distance less than 30 cm from the device.

## 2 — PRODUCT DESCRIPTION

### 2.1 — GENERAL

The Minilight syringe is a medical device designed to blow air and water (separately or together, at room temperature or at body temperature) to clean and/or dry the oral cavity during any dental procedure. It has been designed for use in dentist offices and dental clinics and is built into dental unit used exclusively by dentists. Product life — under proper maintenance conditions — is 5 years.

### 2.2 — GENERAL CHARACTERISTICS

- The Minilight syringe is a medical device for dental use (class II a).
- Protection rating against direct contacts: B
- Temporary operation: 10 sec. ON/ 20 sec. OFF.

The Minilight syringe has been designed using the latest ergonomic concepts for easy use and immediate cleaning and sterilisation. Both the tip and handpiece can easily be removed for perfect autoclave disinfection and sterilisation at 134°C (see point 8). Several handpieces of different shape are available. Choose the shape you need: angled or stylet. The air and water can also be heated to body temperature, thus sparing the patient even the slightest discomfort induced by insufflation of products at ambient temperature.

### 2.3 — MODELS

The models are differentiated into versions based on the

number of functions provided:

- 3F: cold water/air/spray
- 6F: cold water/air/spray - warm water/air/spray
- G3F: cold water/air/spray (air and water inverted)
- G6F: warm water/air/spray (air and water inverted)
- A: cold water or air only
- L: cold/warm water, air and spray + light

Note:

Models 3F, G3F, 6F, G6F and L can be recognized by the printing on the back of the syringe.



Various handpieces, that differ in shape, can be mounted on all versions of the Minilight syringe.

The shape of the handpiece can be:

STYLET



ANGLED



This difference lets the dentist choose the tool ergonomically best suited for the purpose. To guarantee maximum hygiene and atoxicity, the handpieces are made of stainless steel. The devices are produced entirely in our workshop, with a tested, constantly updated work cycle using the most sophisticated machinery compliant with current quality system directives (UNI EN ISO 13485 certified).

## 2.4 — CONTROLS

Every syringe and all of its parts undergo duly documented, 100% complete functional and safety testing to ensure that the technical and functional design requirements are fully met.

## 2.5 — CE MARKING

All products bear CE marking both on syringe handpiece and inside. (batch number, autoclave symbol, Luzzani Dental logo, product name, CE marking with Notified Body number). The User's manual supplied with the product also includes details of our company, the main product characteristics and instructions for correct use and maintenance.

# 3 — IDENTIFICATION DATA AND WARRANTY

## 3.1 — MANUFACTURING BATCH

A number, marked on the inside of each product, identifies the production batch; the number is printed on the central body of the syringe. This number uniquely identifies the production batch thus always guaranteeing traceability of the product and each of its components, with relative test sheets.

## 3.2 — WARRANTY

The product is guaranteed by our company for 12 months from the date of the delivery document. The warranty covers any device manufacturing defects (materials) and is limited solely to the replacement of defective parts, performed in our workshop. The product must be sent to our premises at the expense of the customer. For the warranty to be valid, the product must be returned intact, complete and showing with no signs of tampering. The syringe has no functional expiration date; its expected life span is 5 years.

# 4 — PACKAGING

The product is shipped in suitable packaging to prevent problems during transport. The packaging consists of a plastic bag containing the Minilight syringe. A protective handpiece sheath and tip-saving tube protect the syringe during transport. Several bags are placed in one box. The Minilight syringe comes ready for connection to the dental unit once all packaging has been removed. For the correct use of the syringe, the protective tube must also be removed from the tip.

 **IMPORTANT NOTE:**

With each syringe, the package also includes a User's manual which also includes a "Fault Report Form". Since this is required by law, the user must receive this User's manual. Therefore, the syringe installer is responsible for delivering these forms to the dentist. Directive 93/42/EEC requires product traceability: therefore, our customers are asked to ensure that we can identify the end customer to whom the product has been sold.

## 5 — TECHNICAL CHARACTERISTICS

FUNCTIONS		6F	3F	L
Supply voltage	V~	24	***	24
LED voltage	Vdc	***	***	3,5
Max. absorbed current	A	4,3	***	4,3
Electrical power	W	103	***	103
Water supply pressure	Kpa	250	250	250
Air supply pressure	Kpa	450	450	450
Water flow rate	Cc/min	110	110	110
Air flow rate	NI/min	10	10	10
International protection		IP40	IP40	IP40

### 5.1 — OPERATING CONDITIONS

Ambient temperature	10°C / +45°C
Relative air humidity	30% / 85%
Atmospheric pressure	80 Kpa - 106 Kpa

### 5.2 — TRANSPORT AND STORAGE CONDITIONS

Temperature	-20°C / +60°C
Relative Humidity	30% / 85%
Atmospheric Pressure	50 Kpa - 106 Kpa

## 6 — INSTALLATION AND CONNECTIONS

### 6.1 — CONNECTION TO ELECTRICAL SYSTEM

The connection involves hooking up the two electrical terminals to the transformer, arranged to provide an output of 24 V (see wiring diagram 14.1). Model L only: voltage for LED light 3.3 Vdc: black wire (+), white wire (-)

 **NOTE**

- The electric power supply and transformer used must be rated Safe Extra Low Voltage (SELV) for medical use, in compliance with the mandatory regulations.
- Connection to terminals with output voltage exceeding 24 V could irreparably damage the unit and compromise safety.

### 6.2 — CONNECTION TO HYDRAULIC SYSTEM

The syringe's green line must be hooked up to the water supply.

 **NOTE**

- The operating pressure is 250 kPa. A slight increase in pressure would only increase the power of the jet, but would not create any problems and is not dangerous.
- The water used must be potable water, filtered (<25 µm) and free of bacteria, etc.
- For the syringe to function properly, the water pressure must not be lower than indicated.

### 6.2 — CONNECTION TO COMPRESSED AIR SYSTEM

The syringe's blue line must be connected to the compressed air system.

 **NOTE**

- The recommended operating pressure is around 450 kPa.
- When using the Minilight syringe, national regulations regarding water and air quality must also be met.
- The air must be medical grade, dry and free of oil and bacteria – a 5µm air filter is recommended.

### 6.4 — CONNECTION OF STRESS ABSORBER CORD

The stress absorber cord must be anchored to the dental

unit. This cord is designed to absorb any strains, thus preventing abnormal traction on the electrical or air/water line connections. The manufacturer cannot be held liable for malfunctions caused by failure to anchor the stress absorber cord.

## 6.5 — NOTES FOR CORRECT CONNECTION

- Before carrying out functional tests, both the electric, water and air lines must be correctly connected.
- Using the syringe without connecting the water and air supplies could damage the syringe.
- The lines must be connected carefully since inverting them could damage the syringe.

## 7 — NORMAL USE

### 7.1 — INSUFFLATION OF COLD WATER

To blow cold water into the operating field, just press the left button on the handpiece, symbol: 

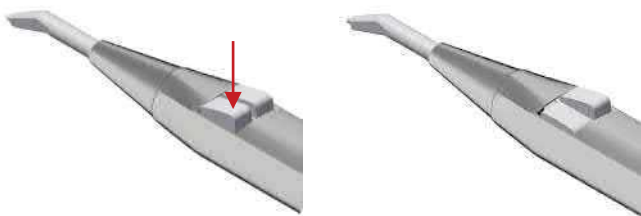

### 7.2 — INSUFFLATION OF COLD AIR

To insufflate cold air into the operating field, just press the right button on the handpiece, symbol: 

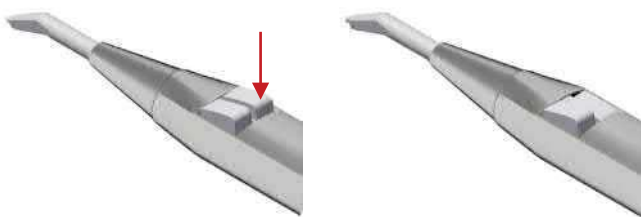

### 7.3 — COMBINED INSUFFLATION OF COLD WATER AND AIR (SPRAY)

To blow a combination of cold air and water (spray), press both buttons on the handpiece at the same time:

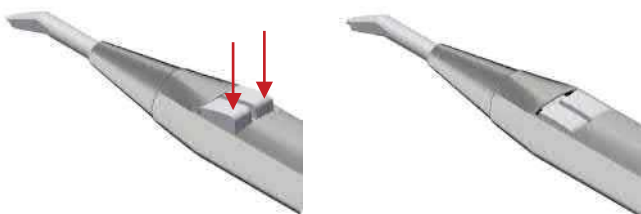

### 7.4 — INSUFFLATION OF WARM WATER (present in version 6f and L)

To blow warm water into the operating field, turn the selector switch at the base of the handpiece to the right (the green

LED lights up)



and press the left button on the handpiece:

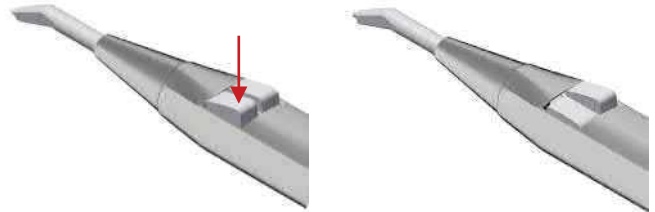

### 7.5 — INSUFFLATION OF WARM AIR (present in version 6f and L)

To blow warm air into the operating field, turn the selector switch at the base of the handpiece to the right (the green LED lights up):



and press the right button on the handpiece:

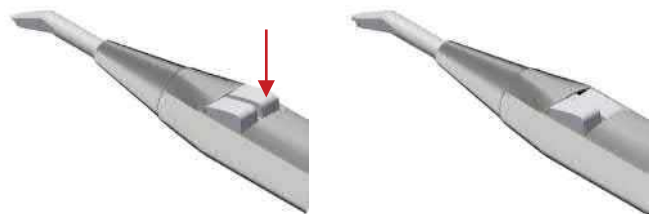

### 7.6 — COMBINED INSUFFLATION OF WARM WATER AND AIR (SPRAY) (present in version 6f and L)

To blow a combination of warm air and water (spray), turn the selector switch at the base of the handpiece to the right (the green LED lights up)





and press both buttons on the handpiece at the same time:

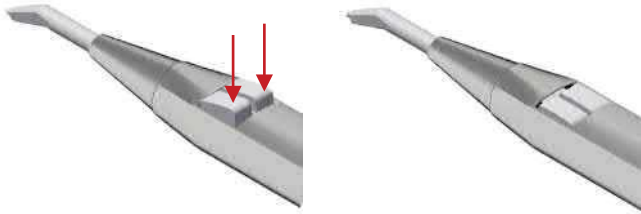

### 7.7 — LIGHT FUNCTION (present in version L)

This function is present in the Minilight L version. In this model, the handpiece has an optical fibre that conducts the light generated by a LED located in the body of the syringe. We recommend using a switch to turn the LED on and off. For connections, see wiring diagram 14.2.



#### NOTE

- The sole function of the selector switch is to preselect warm operations. The water and/or air are only heated at the moment in which they are actually used.
- The cleaning (or line washing) procedures must always be performed in the cold position.

#### WARNING

Do not use the tip improperly. Remove and sterilise the tip after each patient.

#### IMPORTANT

Air and water must be able to flow freely from the tip. Do not rest the tip on the tooth or on an object. Do not press the tip against impression materials as they could cause obstruction

### 7.8 — FIRST TIME USE AND USE AFTER LONG INTERVALS

-  Sterilize the handpiece and all accessories before use.
- After prolonged periods of inactivity, clean, treat and sterilise the handpiece.

#### BEFORE EACH PATIENT

1. Make certain the handpiece has been sterilised.
2. Adjust the supply of fluids from the dental unit (see table in point 5).
3. Press the air button and make certain that there is a clearly perceptible jet of air.
4. Check the water flow rate.
5. Use only filtered water that is free of oil and microorganisms.

6. Check the tip for any obstructions or deposits. Clean if necessary.

#### NOTE

- Flush out the syringe at the beginning of each work day (minimum flushing time: 2 minutes) and before each patient (minimum flushing time: 20-30 sec.).
- Immediately upstream of the syringe, install filters able to retain the microorganisms coming from the hydro-pneumatic circuit.

## 8 — CLEANING AND STERILIZATION

-  After each use on a patient, the handpiece and tip of the syringe **MUST** be cleaned and sterilised to guarantee maximum hygiene.

Sterilisation symbol on the handpiece: 

To do this, proceed as follows:

Disconnect the tip by unscrewing the tip retainer

1. unscrew the tip retainer

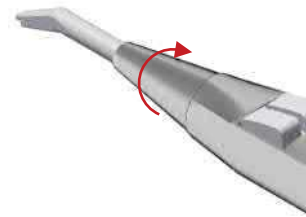

2. withdraw the tip retainer



3. withdraw the tip



or remove the entire handpiece by pressing the button on the lower part of the handpiece and pulling upwards.

1. press the pawl to release the handpiece

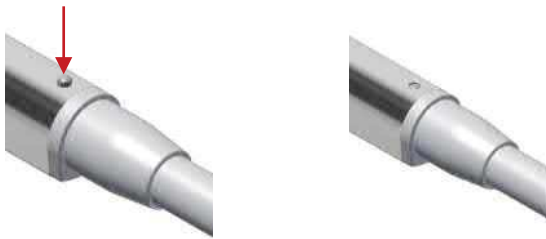

2. withdraw handpiece



wipe with a damp cloth, removing any stains. Set in a steam autoclave at 134°C for AT LEAST 3 minutes (in compliance with CEI EN 13060).

#### A — WARNINGS

 The syringe should always be sterilised, even before using it for the first time.

- Inappropriate sterilisation is hazardous for the patient and for the operators.
- Do not perform spray disinfection.
- Do not immerse in disinfectant liquids.
- Do not perform cold or hot air chemical sterilisation.
- The personnel performing the task must be skilled and specially trained.
- Use disinfectant according to the specifications on the manufacturer label.
- Do not use chlorine-based liquids.
- When simultaneously sterilising more than one item in an autoclave, check that the load does not exceed the maximum allowed.

#### B — PREPARATION

Eliminate surface dirt using a disposable paper towel. Clean the inside of the lines by running air and water through the syringe for about 30 seconds. Remove the stainless-steel handpiece by pressing the button on its terminal section. Unscrew the tip retainer and remove the tip.

#### C — MANUAL CLEANING

Use a disposable paper towel and potable water to remove any impurities or dirt that may be present

#### D — AUTOMATIC CLEANING

Not envisaged

#### E — MANUAL DISINFECTION

Disinfect only with a disposable cloth and the permitted disinfectant (following the instructions on the label and product technical data sheet).

Recommended disinfectants:

- Incidin liquid
- FD 322 Durr
- Mikrozid AF liquid

#### F — AUTOMATIC DISINFECTION

Not envisaged

#### G — MANUAL DRYING

Dry with disposable paper towelling. Dry with clean, dry, uncontaminated compressed air, inside and out, continuing until completely dry. Do not dry with hot air.

#### H — AUTOMATIC DRYING

Not envisaged

#### I — MAINTENANCE AND CONTROL

No special maintenance is necessary. There is no objective period of time that limits the useful life of the handpiece: visually check for damage and signs of wear, and if found, replace the part.

#### L — PACKAGING

Use heat sealable film-paper sterilisation pouches of appropriate size.

#### M — STERILISATION

The handpiece and tip can be sterilised.

Sterilise in a class B steam autoclave in compliance with EN 13060 ISO 17665-1.

3-phase sterilisation with fractional vacuum system at 134°C +/- 1°C at a pressure of 2.13 bar, applying a 4-minute delay. Never exceed 134°C. The autoclave must be validated.

#### N — STORAGE

No particular requirements apart from storage in the sealed, sterilised pouches. Store in a suitable place that is dry, out of direct sunlight and possibly with low bioburden.

## 9 — MAINTENANCE

The instrument requires no specific maintenance apart from normal cleaning and sterilisation as described in the previous paragraph.

## 10 — DISPOSAL AND SCRAPPING

-  The product does not contain dangerous or toxic-hazardous components. Separate waste collection is required for electrical equipment. Follow the regulations in force in your country.

## 11 — INFORMATION FOR THE DENTIST













-  The dental unit manufacturer is required to deliver the Luzzani Dental syringe User's manual to the end user.

## 12 — FAULT REPORT FORM

To meet the requirements of Directive 93/42/CEE as amended, the company has established a post-marketing surveillance procedure to monitor any problems generated by the use of our products. This commitment includes the requirement that both user and manufacturer inform the competent authorities of any incident caused to patient or user by malfunction or deterioration in the characteristics and/or performance of a device, as well as any inadequacy in the instructions for use. We kindly ask you to inform us of any anomalies by sending us the sheet attached to the last page of this manual.

## 13 — SYMBOLS

### SYMBOLS

- |   |   |   |                       |
|---|---|---|-----------------------|
|  | Do not overturn   |  | Batch number          |
|  | Fragile   |  | Sterilise             |
|  | Keep dry  |  | Consult User's manual |
|  | Type B device   |   |                       |
|  | Alternating current   |   |                       |
|  | General warnings  |   |                       |
|  | Separate collection for electrical and electronic equipment |   |                       |
|  | Manufacturer  |   |                       |
|  | Double insulation   |   |                       |

14 — WIRING DIAGRAM



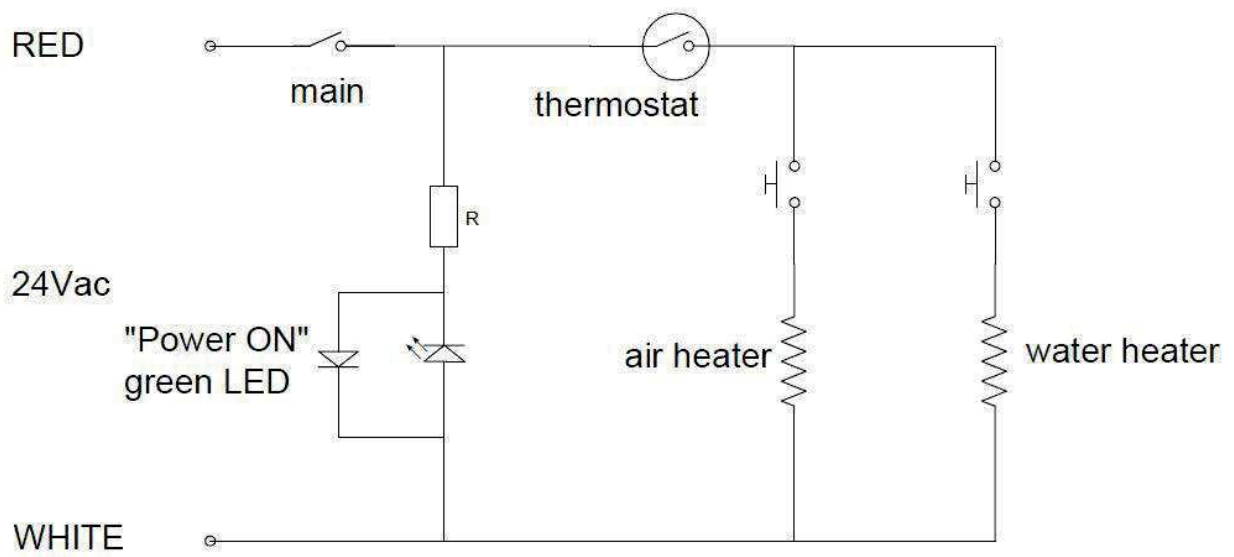

14.1 – VERSION 6F

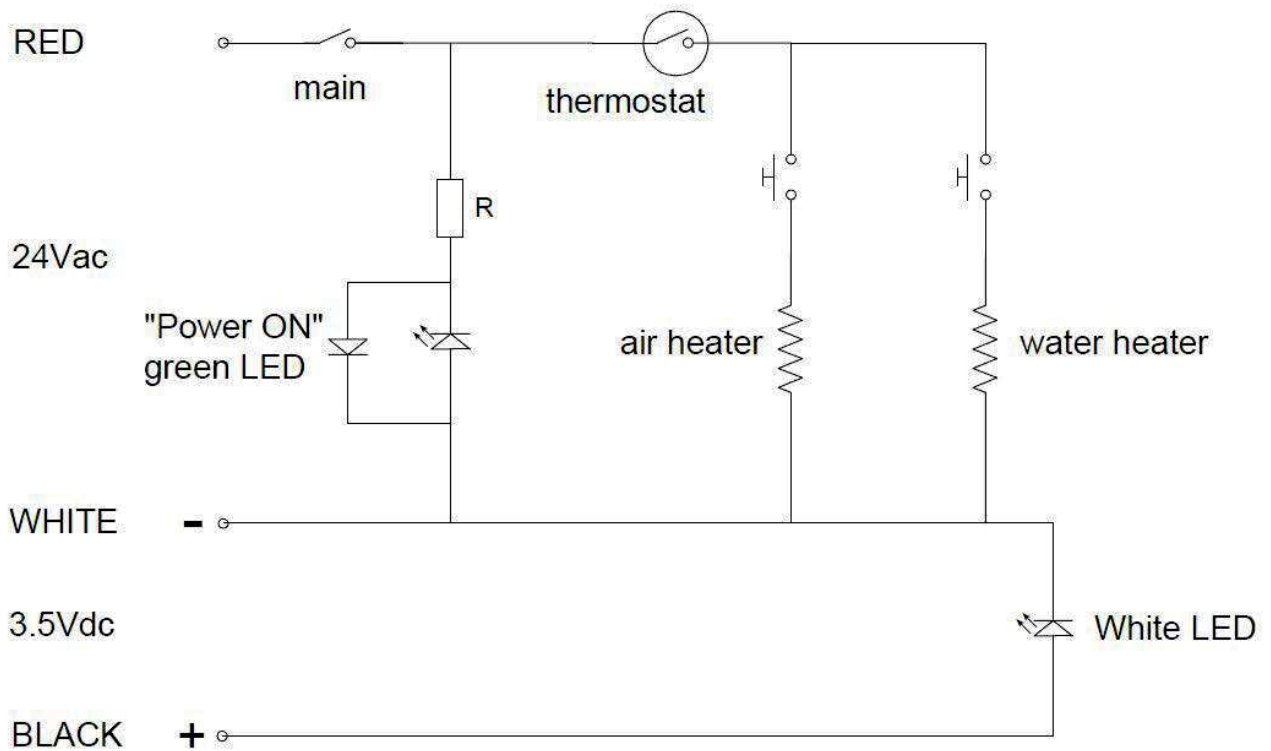

14.2 – VERSION L



## INSTRUCTIONS FOR CLEANING AND STERILIZATION OF MINILIGHT, MINIMATE, MINIBRIGHT SYRINGES IN ACCORDANCE WITH UNI EN ISO 17665 REQUIREMENTS

<p>Warning</p> 	<ul style="list-style-type: none"> <li>• Sterilization must be performed even when using the syringe for the first time.</li> <li>• Inappropriate sterilization is dangerous for patients and operators.</li> <li>• Do not perform spray sterilization. Do not place in any disinfectant liquids.</li> <li>• Do not perform cold chemical or hot air sterilization.</li> <li>• The appointed staff must be specialized and trained.</li> <li>• Use the disinfectant in accordance with the specifications set by the manufacturer indicated on the label.</li> <li>• Do not use chlorine-based solutions.</li> <li>• When sterilizing more than one piece in one autoclave do not exceed its maximum load capacity.</li> </ul>
<p>Preparation</p>	<p>Remove dirt from the surface using a disposable paper tissue. Let air and water flow from the syringe for about 30 seconds in order to clean the internal channels. Press the button located at the bottom of the sleeve and slide the stainless steel sleeve off the syringe body. Unscrew the ferrule and remove the tip.</p>
<p>Manual cleansing</p>	<p>Wipe with a disposable paper tissue and with the aid of drinking water to remove any impurities and dirt</p>
<p>Automatic cleansing</p> 	<p>Not available</p>
<p>Manual disinfection</p>	<p>Perform disinfection only with a disposable tissue and with compatible disinfectants (in accordance with the instructions included in the product label and technical data sheet). Recommended disinfectants:</p> <ul style="list-style-type: none"> <li>• Incidin liquid</li> <li>• FD 322 Durr</li> <li>• Mikrozyd AF Liquid</li> </ul>
<p>Automatic disinfection</p> 	<p>Not available</p>
<p>Manual drying</p>	<p>Dry with disposable paper tissue. Dry with dry, clean and uncontaminated compressed air both internally and externally until completely dry. Do not dry with hot air.</p>
<p>Automatic drying</p>	<p>Not available</p>
<p>Maintenance and checking</p>	<p>No particular maintenance is required. There is no objective term limiting the usage life of the sleeve: check to see if there are if any damages or signs of wear and tear, replace the part if necessary.</p>
<p>Packaging</p>	<p>Use appropriately sized sterilization packages made of thermoweldable film.</p>
<p>Sterilization</p> 	<p>The sleeve and tip are autoclavable. Sterilize using EN 13060 ISO 17665-1 compliant class-B steam autoclave. Sterilize with 3 phases fractionated vacuum 134° C +/- 1 °C with 2.13 bar pressure, 4 minutes wait. Never exceed 135° C. The autoclave must be validated.</p>
<p>Preservation</p>	<p>No particular requirements other than keeping them in their sealed and sterilized package. Keep them in an appropriate environment and out of direct sunlight and in a dry place, which should have low bioburden where possible.</p>

# FAULT REPORT FORM

PRODUCT \_\_\_\_\_

TYPE \_\_\_\_\_ BATCH \_\_\_\_\_

REPORTED BY \_\_\_\_\_

COMPANY \_\_\_\_\_

## TYPE OF REPORT

ANOMALY

SUGGESTIONS

\_\_\_\_\_

## DESCRIPTION

---

---

---

---

---

## NOTES

---

---

---

---

---

DATE \_\_\_\_\_

SIGNATURE \_\_\_\_\_

## SEND TO:

LUZZANI DENTAL SRL  
Via Torino 3 - Senago (MI) - ITALY  
Tel. +39 02 99010379)